



Milano
Bright Light Bright Life

ELECTRICAL(B2C)
CATALOGUE

DANUBE

Celebrates it's



DANUBE GROUP

Established in the year 1993, Danube Group was founded and cultivated under the leadership of Rizwan Sajan, who is the known to be the Founder and Chairman of the Group. Starting off as a small trading firm, the company is moving from strength-to-strength, expanding its foothold in the region, and has established itself as the No. 1 building Materials Company along with other branches under its vast umbrella. In 2015, the company recorded a turnover of AED 5.14 billion and has been growing ever since.

DANUBE
No.1 building material company

DANUBE
PROPERTIES

DANUBE
HOME

Milano

ALUCOPANEL
U.S.A



ABOUT MILANO

Milano, wholly owned by Danube Group, was established in Italy in 2006 and registered worldwide. The brand exhibits a wide range of affordable luxury products under one roof. The products portfolio include: sanitary ware, electrical products, tiles, water purifier, hardware and furniture fittings. We cater to our global clientele through a worldwide network of commercial branches, representative offices, distributors and project partners. Our team of experts oversee 5 divisions with 50 showrooms in Middle East and the support of more than 5000 distributors across the world. Milano has earned an unparalleled reputation as one of the leading brands in 47 countries. Whether you like simplicity or luxury, Milano range covers all individual preferences and serves as a one-stop solution to suit all kinds of lifestyles. Milano ensures that its products live up to the uncompromising demands in terms of workmanship and functionality.

VISION

Our vision is to be globally recognized brand that provides affordable luxury sanitary ware, electrical products, tiles, water purifier, hardware and furniture fittings.

MISSION

Our mission is to set and maintain high standard of quality, technology, design and sustainability. We set our standards high to ensure that every time you purchase a Milano product, you can feel the difference.

VALUES

Quality : Provide outstanding products and unsurpassed customer service that together deliver premium value to our customers and distributors.

Integrity : Uphold the highest standards of integrity in all of our actions.

Commitment : Develop lasting relationship through commitment towards our teams, our services and products so as to become the best.



MESSAGE FROM MANAGING DIRECTOR

MR. ANIS SAJAN

Managing Director Danube Group

Milano has continued the course of success with focused and advanced vision. Our team's innovation, drive and dedication towards our clients have been the key to Milano's constant growth, year after year. We believe the best way to predict the future is to design it and we at Milano, are focused on designing and offering futuristic products that are practical, efficient and environment friendly. We take this opportunity to reiterate our commitments, to offer quality products with long-term value. This is what truly differentiates us from all our competitors.

MESSAGE FROM DIRECTOR

MR. ADEL SAJAN

Director Danube Group

It's Always Customer Needs Matter!!!

Taking care of our customer, paying more attention to the customer demands, understanding the needs & meeting their requirements with affordable prices has always been top priority for us.

We continuously strive to focus more on innovations, new technologies, which enables them to enjoy more efficiently & make peoples life more safe & comfortable.

Milano offers wide range of lighting (indoor & outdoor), switches, Fans & VPDS, Available across all our stores in UAE, OMAN, BAHRAIN & KUWAIT. With these range it makes complete one stop shopping solution for all your residential & commercial needs.



MESSAGE FROM PRODUCT MANAGER

MR. PRADEEP BADDI

Product Manager-Electrical

Since the inception of electrical products under the Milano brand, our customer-centric approach has always been our key strength. Our commitment is to deliver innovative and superior quality products that cater to our customer's needs and lifestyle. Our products like lightings, wiring accessories, fans and video door phones, are all well-crafted to suit various types of interiors and exteriors and are highly appreciated for their performance, reliability and functionality. At Milano, we will continue to design and offer user-friendly and unique spectrum of affordable products that add elegance, sophistication and style to every home, villa and office."



ABOUT LED

What is the LED?

LED is the acronym for light-emitting diode (Light Emitting Diode), which is a semiconductor solid light emitting device, it is the use of solid semiconductor chip as luminescent material, when ends with a positive voltage, the semiconductor carrier recombination occurs caused by photon emission and to produce light.

LED lighting:

It is the use of LED as a light source of lighting.

What is the COB?

COB (Chip On Board) LED chip light source is directly attached to the metal substrate high specular reflectance, forming high-efficiency integrated surface light source.

Color temperature:

Unit: kelvin (K) when the color of light emitted by "blackbody" at a certain temperature the color photograph of radiation at the same time, the temperature "blackbody" is called the color temperature of light source. "blackbody" the higher the temperature, the spectrum of blue components, the more and the less the red components. Incandescent light color is warm white, for example, said the color temperature is 2700 k, and the sun color fluorescent color temperature of the said method is 6500k.

Color rendering:

Light for the degree of colors is called color rendering. Usually called "color rendering index" (Ra).

Refers to the real things color (its own color) and a standard light shows the color of the relationship. The determination of Ra value is DIN6169 standards defined in the eight kinds of testing color in standard light source and the tested under the light source, the smaller the color difference is showed by metering source color the better color rendering.

Beam angle:

It refers to the vertical plane of the beam center line, the luminosity equal to 50% of the maximum angle between two directions between luminosity. Beam angle is reflected in the wall spot size and intensity. If the application of the same light source at different angles reflector, the greater the beam angle, the center of the light intensity weaker, the softer spot. The smaller the beam angle, the center of the light intensity, the stronger, the more intense the spot.

Luminous flux:

Unit is: lumen (lm) light source emission and human eye perception of radiant energy is called the luminous flux.

Light intensity:

Light source in a certain direction within the solid angle of luminous flux in size. Unit: candela (candela, cd) in general, will light in different directions with different intensity of the emitted luminous flux. In a particular direction the visible radiation intensity is called out by the light intensity.

INDEX

LED LIGHTING

▪ LED SLIM PANEL LIGHT ROUND	01
▪ LED SLIM PANEL LIGHT SQUARE	03
▪ LED 3 IN 1 DIMMABLE PANEL LIGHT (RD/SQ)	05
▪ 595 x 595 / 600 x 600 LED SLIM PANEL LIGHTS	07
▪ LED SURFACE LIGHT ROUND	09
▪ SQUARE SURFACE LIGHT SQUARE	11
▪ LED DECORATIVE CEILING LIGHTS	13
▪ LED DOWN LIGHT CURVED SERIES	15
▪ LED COB DOWN LIGHT IP-44	17
▪ SMD DOWN LIGHT IP-65	19
▪ LED DIMMABLE / REGULAR SPOT LIGHT	21
▪ LED 3 IN 1 COLOR SPOT LIGHT	23
▪ LED IP-65 SPOT LIGHTS	25
▪ LED COB MR-16 & GU-10	27
▪ LED CANDLE LAMP	29
▪ LED BULBS	31
▪ LED STRIP LIGHTS 2835 & 5050	33
▪ LED T5 FITTING	35
▪ RECHARGEABLE EMERGENCY LIGHT	37
▪ SENSORS	39
▪ DECORATIVE LED MIRROR LIGHTS	41
▪ LED MIRROR LIGHTS	43
▪ LED Highbay LIGHTING	45
▪ LED IP-54 CEILING LIGHT	47
▪ LED TRIPROOF FITTINGS IP – 65	49
▪ 360 D LED SMD FLOOD LIGHT	51

▪ LED RECHARGEABLE FLOOD LIGHT	53
▪ LED WALL BRACKETS	55
▪ LED IP-54 CEILING LIGHT/WALL BRACKETS	57
▪ LED OUTDOOR WALL BRACKET	59
▪ LED UNDERGROUND LIGHTS	63
▪ LED CONSEALED STEP LIGHTS	65
▪ LED SPIKE LIGHT	67

WIRING DEVICES

▪ BRUSHED GOLD	71
▪ BRUSHED SILVER	73
▪ METAL PLATE WHITE	75
▪ BASIC WHITE	77
▪ CEILING ROSE/WATER PROOF	80
▪ DOOR BELL	81

FANS & COOLERS

▪ ORCHID & VIEANNY CEILING FAN	v	83
▪ AUTO SHUTTER EXHAUST FAN		85
▪ EXHAUST FAN ROUND/SQUARE		87
▪ MIST FAN		89
▪ AIR COOLER		91
▪ VIDEO DOOR PHONE		97
▪ INTERCOM & CALLING BELL		99

PRODUCT FINDER



SLIM PANEL LIGHTS



01



03



05



05



07

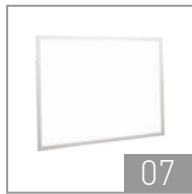

07



SURFACE LIGHTS



09



11



DECORATIVE CEILING LIGHTS



13



13



13

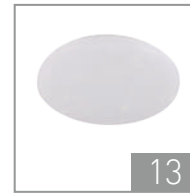

13



13



DOWN LIGHTS



15



17



19



SPOT LIGHTS



21



21



23



23



23

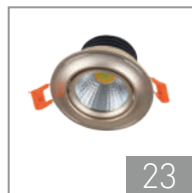

23



25



25



27



27



PRODUCT FINDER

LED CANDLE LAMP & BULBS



LED STRIP LIGHTS

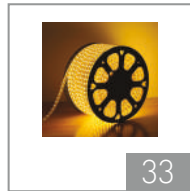

LED T5 LIGHT



EMERGENCY LIGHT & SENSORS



LED MIRROR LIGHTS



LED HIGHBAY & CEILING LIGHTS



PRODUCT FINDER

LED WATER PROOF FITTINGS



LED FLOOD LIGHTS

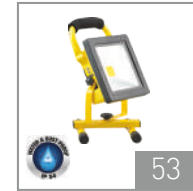
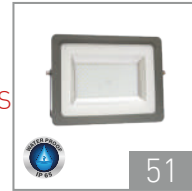

LED OUTDOOR WALL BRACKETS & WALL LIGHTS

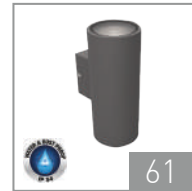
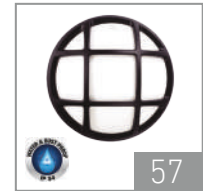

LED UNDER GROUND STEP/SPIKE LIGHTS



WIRING DEVICES

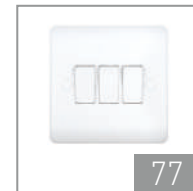
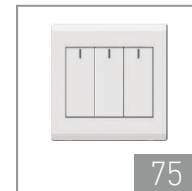

CEILING FANS



PRODUCT FINDER

EXHAUST FANS



AIR COOLERS



VIDEO DOOR PHONE
INTERCOM
& CALLING BELL





SLIM PANEL
LIGHTS

LED SLIM PANEL LIGHT ROUND



Description:

The Milano slim panel lights are designed to deliver superior brightness and uniformity due to its latest LED technology.

The thickness of the light is 22mm and it comes in a white matt finish. They are ideal lighting solutions for gypsum ceilings, which requires high lumen output.



LED SLIM PANEL LIGHT ROUND

• Product Features:

1. High standard Aluminium die-casting & high thermal conductive silicon which provides quick heat dissipation.
2. High quality LED chips are mercury free and prevents discoloring, providing brighter & uniformity light.
3. High quality acrylic light guide plate (LGP) gives good reflectivity & high permeability.
4. High color rendering Index (CRI) ≥ 80 , restores true color of the object.
5. Adopts constant current supply to start up the light quickly has high energy saving & does not flicker.
6. Easy installation & zero maintenance.

• Application:

Commercial, Residential, Hospital, Restaurant, Shopping mall etc.

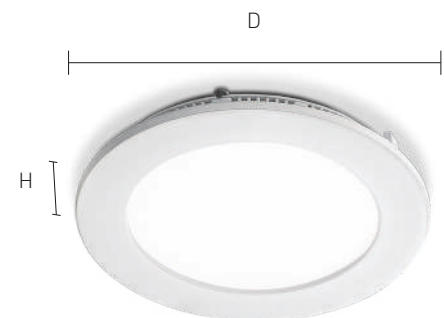



Barcode	Product Size(mm)	Voltage	Life span	Power	Color Temp	Lumen(lm)	Std pkg
210300100001	D:85 H:22 Cut:70	85-265V	25,000 Hrs	3W	6500k	≥240	50
210300100002	D:85 H:22 Cut:70	85-265V	25,000 Hrs	3W	3000k	≥240	50
210300100003	D:120 H:22 Cut:100	85-265V	25,000 Hrs	6W	6500k	≥480	40
210300100004	D:120 H:22 Cut:100	85-265V	25,000 Hrs	6W	3000k	≥480	40
210300100005	D:170 H:22 Cut:150	85-265V	25,000 Hrs	12W	6500k	≥960	30
210300100006	D:170 H:22 Cut:150	85-265V	25,000 Hrs	12W	3000k	≥960	30
210300100007	D:225 H:22 Cut:200	85-265V	25,000 Hrs	18W	6500k	≥1440	20
210300100008	D:225 H:22 Cut:200	85-265V	25,000 Hrs	18W	3000k	≥1440	20
210300100009	D:300 H:22 Cut:280	85-265V	25,000 Hrs	24W	6500k	≥1920	10
210300100010	D:300 H:22 Cut:280	85-265V	25,000 Hrs	24W	3000k	≥1920	10

LED SLIM PANEL LIGHT SQUARE



Description:

The Milano slim panel lights are designed to deliver superior brightness and uniformity due to its latest LED technology.

The thickness of the light is 22mm and it comes in a white matt finish. They are ideal lighting solutions for gypsum ceilings, which requires high lumen output.



LED SLIM PANEL LIGHT SQUARE

• Product Features:

1. High standard Aluminium die-casting & high thermal conductive silicon which provides quick heat dissipation.
2. High quality LED chips are mercury free and prevents discoloring, providing brighter & uniformity light.
3. High quality acrylic light guide plate (LGP) gives good reflectivity & high permeability.
4. High color rendering Index (CRI) ≥ 80 , restores true color of the object.
5. Adopts constant current supply to start up the light quickly has high energy saving & does not flicker.
6. Easy installation & zero maintenance.

• Application:

Commercial, Residential, Hospital, Restaurant, Shopping mall etc.





Barcode	Product Size(mm)	Voltage	Life span	Power	Color Temp	Lumen(lm)	Std pkg
210300100011	L:85 H:22 Cut:70	85-265V	25,000 Hrs	3W	6500k	≥240	50
210300100012	L:85 H:22 Cut:70	85-265V	25,000 Hrs	3W	3000k	≥240	50
210300100013	L:120 H:22 Cut:100	85-265V	25,000 Hrs	6W	6500k	≥480	40
210300100014	L:120 H:22 Cut:100	85-265V	25,000 Hrs	6W	3000k	≥480	40
210300100015	L:170 H:22 Cut:150	85-265V	25,000 Hrs	12W	6500k	≥960	30
210300100016	L:170 H:22 Cut:150	85-265V	25,000 Hrs	12W	3000k	≥960	30
210300100017	L:225 H:22 Cut:200	85-265V	25,000 Hrs	18W	6500k	≥1440	20
210300100018	L:225 H:22 Cut:200	85-265V	25,000 Hrs	18W	3000k	≥1440	20
210300100019	L:300 H:22 Cut:280	85-265V	25,000 Hrs	24W	6500k	≥1920	10
210300100020	L:300 H:22 Cut:280	85-265V	25,000 Hrs	24W	3000k	≥1920	10

3 IN 1 DIMMABLE PANEL LIGHT

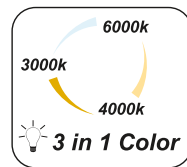
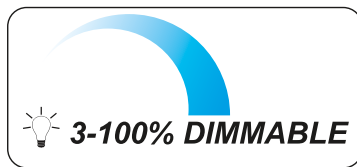

Description:

Milano smart lighting series includes high performance intelligence lighting devices with remote control systems. Which helps to adjust the brightness according to your mood.

Color temperature from 3000k to 6000k and brightness from 3% to 100% and color can be changed with the help of remote.



3 IN 1 DIMMABLE PANEL LIGHT (RD/SQ)

Product Features:

1. High standard Aluminium die-casting & high thermal conductive silicon which provides quick heat dissipation.
2. High quality LED chips are mercury free and prevents discoloring, providing brighter & uniformity light.
3. High quality acrylic light guide plate (LGP) gives good reflectivity & high permeability.
4. High color rendering Index (CRI) ≥ 80 , restores true color of the object.
5. Adopts constant current supply to start up the light quickly has high energy saving & does not flicker.
6. Easy installation & zero maintenance.
7. Remote controlled panel light.
8. Dimmable between 3%-100% with the help of a remote.
9. Color can be changed from 2700k - 6000k using remote.

• Application:

1. Commercial, Residential, Hospital, Restaurant, Shopping mall etc.





Barcode	Product Size(mm)	Voltage	Lifespan	Power	Color Temp	Lumen(lm)	Std pkg
210300100025	D:85 H:22 Cut:70	85-265V	25,000 Hrs	6W+6W SQ	3 in 1 Dim	≥480	40
210300100026	D:85 H:22 Cut:70	85-265V	25,000 Hrs	12W+12W SQ	3 in 1 Dim	≥480	30
210300100027	D:120 H:22 Cut:100	85-265V	25,000 Hrs	18W+18W SQ	3 in 1 Dim	≥960	20
210300100022	D:120 H:22 Cut:100	85-265V	25,000 Hrs	6W+6W RD	3 in 1 Dim	≥960	40
210300100023	D:170 H:22 Cut:150	85-265V	25,000 Hrs	12W+12W RD	3 in 1 Dim	≥1440	30
210300100024	D:170 H:22 Cut:150	85-265V	25,000 Hrs	18W+18W RD	3 in 1 Dim	≥1440	20
210300200001	Remote	N/A	N/A	N/A	N/A	N/A	100

600X600 SLIM PANEL LIGHTS

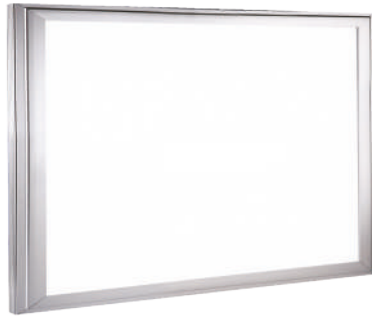

600 x 600 Aluminium

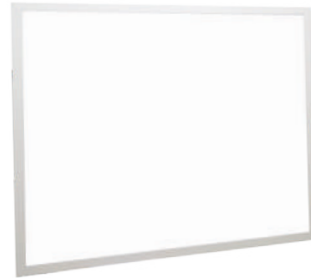

595 x 595



595x595

The Milano 595x595 LED slim panel light is suitable for gypsum tile ceiling and is widely used in office institution and commercial spaces. The advance Aluminium heat sink disputes unwanted heat. (This light has approval from ESMA)

600x600

The Milano 600x600 Alu frame LED slim panel light is suitable for Aluminium ceiling and are widely used for commercial and residential. These panels have an elegant finishing and high in lumen output.

Note: 595x595 LED slim panel light suitable for gypsum ceiling
600x600 LED slim panel light suitable for Aluminium ceiling



595 x 595 / 600 x 600 LED SLIM PANEL LIGHTS

• Product Features:

1. Slim and stylish design.
2. Instant start, No flickering and no humming.
3. High quality Aluminium frame with one piece of acrylic light guide plate.
4. Beam angle at 120° and PF ≥0.8
5. Hanging wires available at additional cost.

• Application:

Commercial, Hospitals, Retail stores, Shopping malls etc.

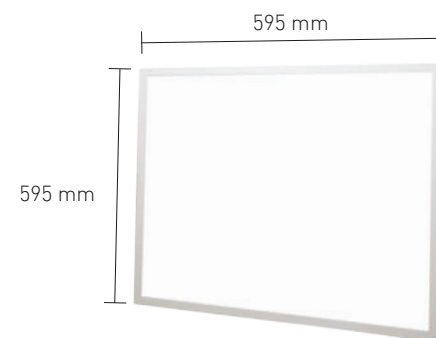
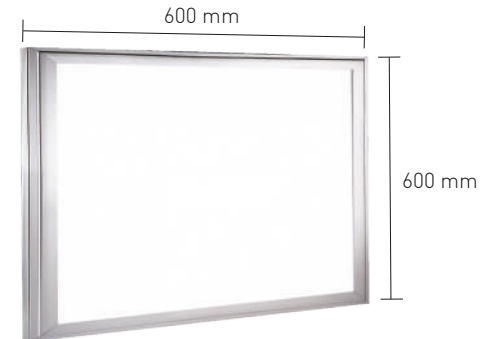

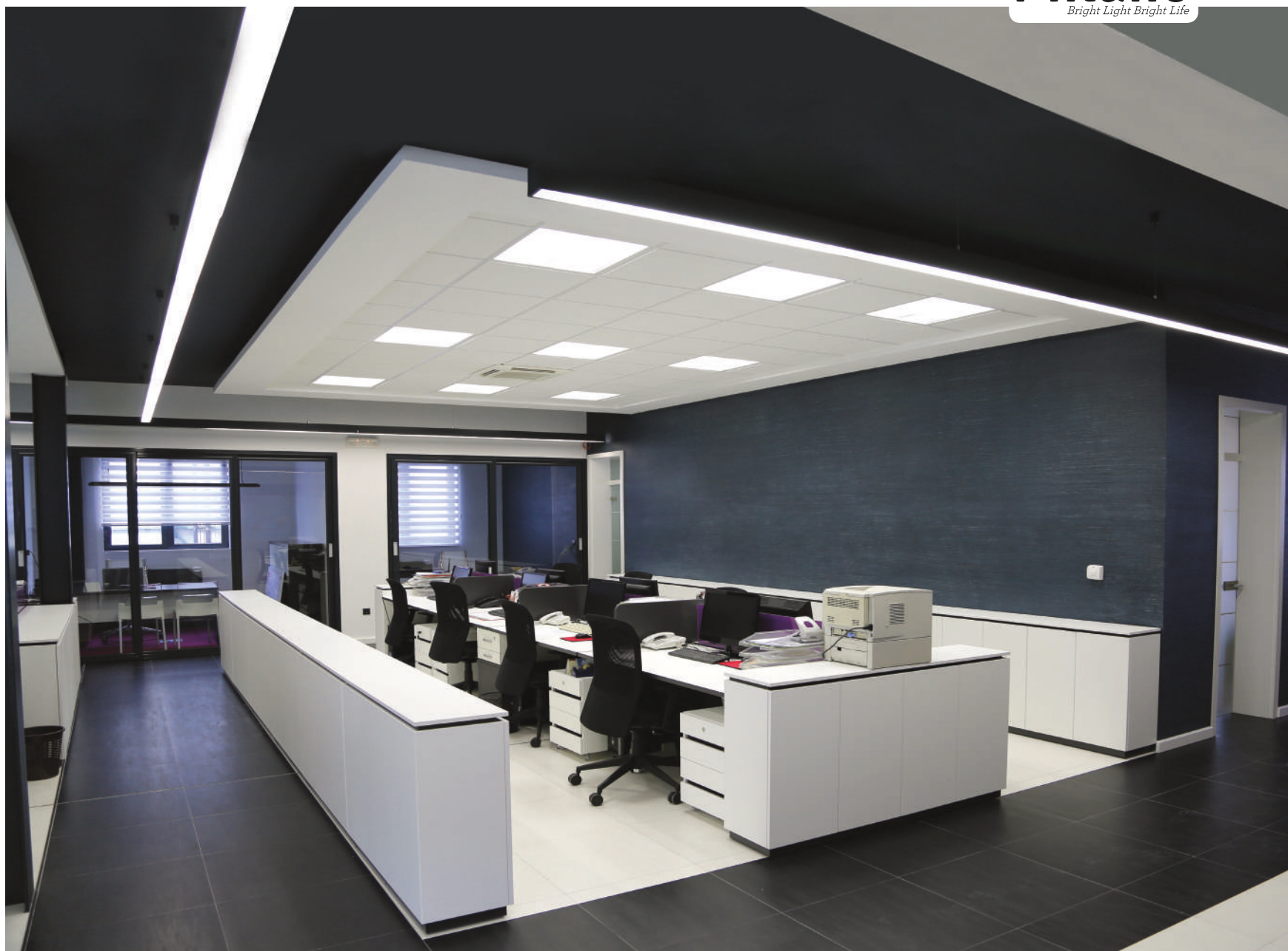

Barcode	Description	Size(mm)	Voltage	Lifespan	Power	Color Temp	Lumen(lm)	Std pkg
210300100021	LED Panel Light Alu. Ceiling	600x600	85-265V	25,000 Hrs	40W	6000K	≥3200	5
210300100028	LED Panel Light Gypsum Ceiling	595x595	220-240V	25,000 Hrs	45W	6500K	≥3800	4
210100200159	Panel Light Hanging Wire	N/A	N/A	N/A	N/A	N/A	N/A	1



LED SURFACE LIGHTS

LED SURFACE LIGHT ROUND



Description:

Milano LED surface lights are designed to replace traditional ceiling light with CFL's. These lights are popular for its easy installation and superior light output due to its latest LED technology.

The light has the height of 40mm with white matt finish frame. They are ideal lighting solution for concrete surface which does not have gypsum ceiling.



LED SURFACE LIGHT ROUND

• Product Features:

1. High standard Aluminium die-casting & high thermal conductive silicon which provides quick heat dissipation.
2. High quality LED chips provides brighter light, uniformity, mercury free & non discoloring.
3. High quality acrylic light guide plate (LGP) gives good reflectivity & high permeability.
4. High color rendering Index (CRI) ≥ 80 , restores true color of the object.
5. Easy installation & zero maintenance.

• Application:

Commercial, Residential, Hospital, Restaurant, Shopping mall etc.

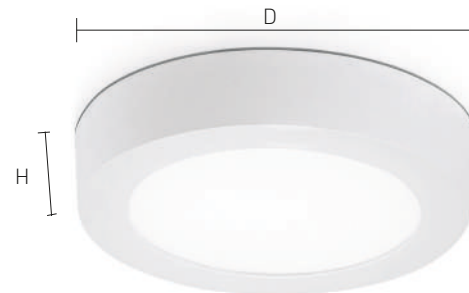



Barcode	Product Size(mm)	Voltage	Lifespan	Power	Color Temp	Lumen(lm)	Std pkg
210301300001	D:120 H:40	85-265V	25,000 Hrs	6W	6500k	≥480	40
210301300002	D:120 H:40	85-265V	25,000 Hrs	6W	3000k	≥480	40
210301300003	D:170 H:40	85-265V	25,000 Hrs	12W	6500k	≥960	30
210301300004	D:170 H:40	85-265V	25,000 Hrs	12W	3000k	≥960	30
210301300005	D:225 H:40	85-265V	25,000 Hrs	18W	6500k	≥1440	20
210301300006	D:225 H:40	85-265V	25,000 Hrs	18W	3000k	≥1440	20
210301300014	D:300 H:40	85-265V	25,000 Hrs	24W	6500k	≥1920	10

LED SURFACE LIGHT SQUARE



Description:

Milano LED surface lights are designed to replace traditional ceiling light with CFL's, these lights are popular for its easy installation and superior light output due to its latest LED technology.

The light has the height of 40mm with white matt finish frame. They are ideal lighting solution for concrete surface which does not have gypsum ceiling.



SQUARE SURFACE LIGHT SQUARE

• Product Features:

1. High standard Aluminium die-casting & high thermal conductive silicon which provides quick heat dissipation.
2. High quality LED chips provides brighter light, uniformity, mercury free & non discoloring.
3. High quality acrylic light guide plate (LGP) gives good reflectivity & high permeability.
4. High color rendering Index (CRI) ≥ 80 , restores true color of the object.
5. Adopts constant current supply to start up the light quickly, high energy saving & no flickering.
6. Easy installation & zero maintenance.

• Application:

Commercial, Residential, Hospital, Restaurant, Shopping mall etc.

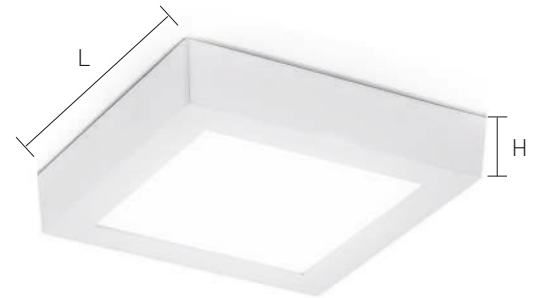



Barcode	Product Size(mm)	Voltage	Lifespan	Power	Color Temp	Lumen(lm)	Std pkg
210301300007	L:120 H:32	85-265V	25,000 Hrs	6W	6500K	≥480	40
210301300008	L:120 H:32	85-265V	25,000 Hrs	6W	3000K	≥480	40
210301300009	L:165 H:32	85-265V	25,000 Hrs	12W	6500K	≥960	30
210301300010	L:165 H:32	85-265V	25,000 Hrs	12W	3000K	≥960	30
210301300011	L:220 H:32	85-265V	25,000 Hrs	18W	6500K	≥1440	20
210301300012	L:220 H:32	85-265V	25,000 Hrs	18W	3000K	≥1440	20
210301300015	L:300 H:32	85-265V	25,000 Hrs	24W	6500K	≥1920	10



DECORATIVE
CEILING LIGHTS

LED DECORATIVE CEILING LIGHTS

210304600016



210304600015



210304600018



210304600017



210304600014



Description:

Milano decorative LED ceiling light are designed with innovative LED technology breaking through traditional lightning features which makes your home more comfortable.

These lights provide high Lumen output and are suitable for your ceiling interiors, with hassle free and easy installation which are ideal to replace the traditional ceiling lights with circular CFL tubes.



LED DECORATIVE CEILING LIGHTS

Product Features:

1. High quality light output
2. Attractive appearance
3. Easy installation
4. Maintenance free
5. Energy saving up to 90%

• Application:

Commercial, Residential, Hotel, Hospital, Restaurant, etc.

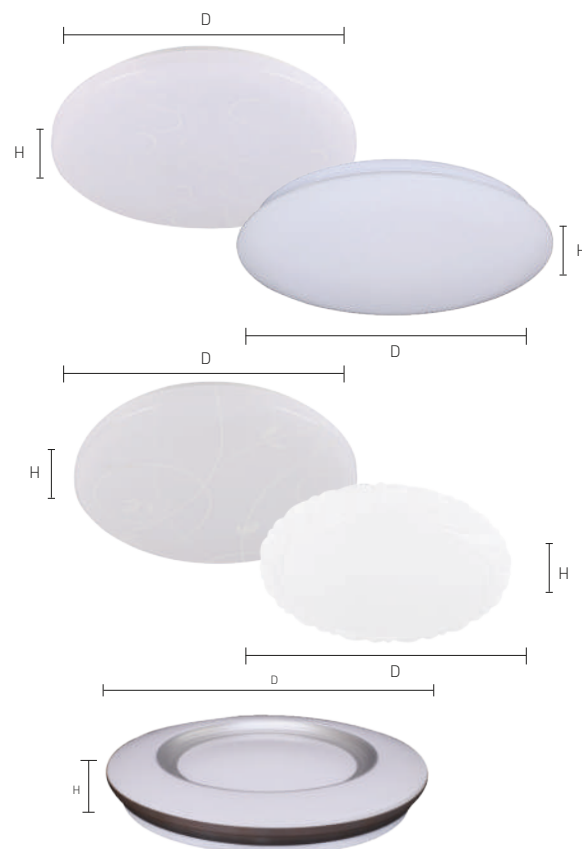

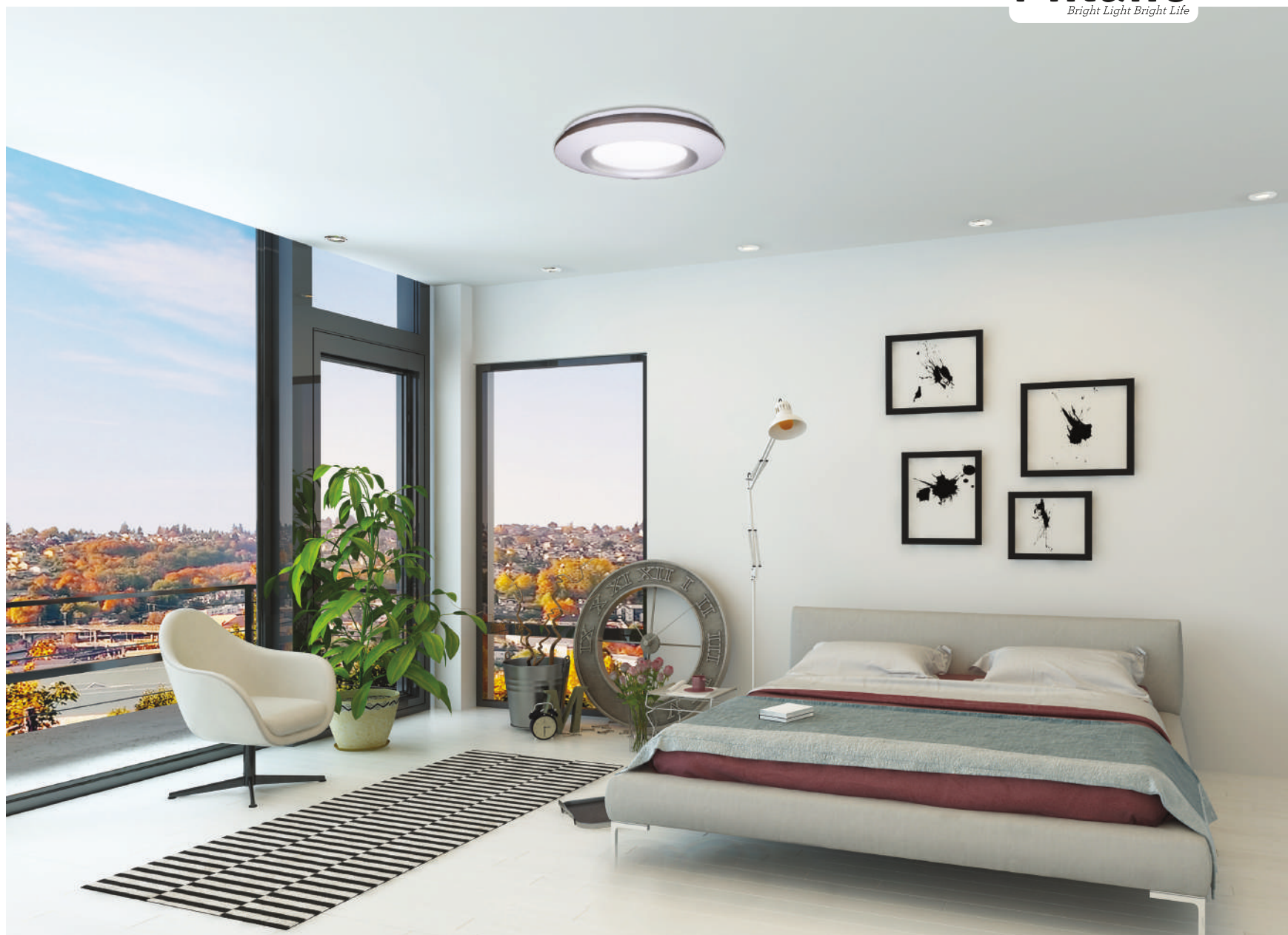

Barcode	Model	Product Size(mm)	Voltage	Power	Lumen(lm)	Color Temp	Std Pkg
210304600014	Sunflower Ceiling Light	D:350 H:60	170-265V	24W	≥2000	6000K	10
210304600015	Plane Ceiling Light	D:350 H:60	170-265V	24W	≥2000	6000K	10
210304600016	Grass Ceiling Light	D:350 H:60	170-265V	24W	≥2000	6000K	10
210304600017	Leaves Ceiling Light	D:350 H:60	170-265V	24W	≥2000	6000K	10
210304600018	Silver Ring Ceiling Light	D:450 H:70	170-265V	36W	≥3000	6000K	5



DOWN LIGHT

LED DOWN LIGHT CURVED SERIES



Description:

Milano LED curved down light series are widely used for commercial lighting. These light consist of high quality LED COB chips to deliver an outstanding light output.

These ranges are ideal because they are new and cost effective solution for a newer existing installation where traditional fluorescent down lights can be replaced.



CURVED SERIES

• Product Features:

1. Attractive appearance, high quality pure Aluminium housing, good heat dissipation and erosion resistant.
2. High CRI ≥ 80 , which restores true color of object.
3. Adopts constant current supply to start up the light quickly.
4. Mercury free Eco friendly and high energy saving.
5. Easy installation & zero maintenance.

• Application:

Commercial, Residential, Hospital, Restaurant, Shopping mall etc.

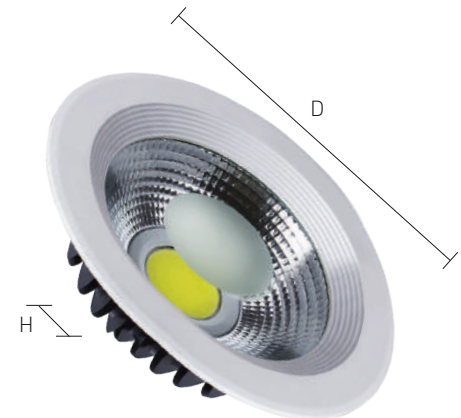



Barcode	Product Size(mm)	Voltage	Lifespan	Power	Color Temp	Lumen(lm)	Std pkg
210300300007	D:145 H:50 Cut:110	85-265V	25,000 Hrs	10W	6500K	≥800	40
210300300008	D:145 H:50 Cut:110	85-265V	25,000 Hrs	10W	3000K	≥800	40
210300300010	D:195 H:60 Cut:165	85-265V	25,000 Hrs	20W	6500K	≥1600	20
210300300009	D:195 H:60 Cut:165	85-265V	25,000 Hrs	20W	3000K	≥1600	20
210300300011	D:225 H:65 Cut:195	85-265V	25,000 Hrs	30W	6500K	≥2400	20
210300300012	D:225 H:65 Cut:195	85-265V	25,000 Hrs	30W	3000K	≥2400	20

LED COB DOWN LIGHT IP-44



Description:

Milano COB downlight IP44 is unique designed with reflector and Citizen COB high power LED chip. ADC12 Aluminium profile provides excellent thermal dissipation. Short heatsink designed for any ceiling installations. Isolated driver solution achieves great quality and stable long lasting light output.



LED COB DOWN LIGHT IP-44

• Product Features:

1. Up to 70% energy saving compared to standard CFL.
2. IP44 for indoor use only.
3. 60° wide beam angle.
4. No UV/IR light.
5. Environment friendly, without Mercury or any other hazardous substances.
6. Easy installation & zero maintenance.

• Application:

Commercial, Residential, Hospital, Restaurant, Shopping mall etc.

Note: These lights will be available against project orders.





Barcode	Model	Product Size(mm)	Voltage	Lifespan	Power	Color Temp	Lumen(lm)	Std pkg
210300300027	COB IP-44	D:110 H:53 Cut:90-100	220-240V	30,000 Hrs	10W	6000K	≥800	30
210300300028	COB IP-44	D:110 H:53 Cut:90-100	220-240V	30,000 Hrs	10W	3000K	≥800	30
210300300029	COB IP-44	D:190 H:75 Cut:160-170	220-240V	30,000 Hrs	25W	6000K	≥2875	12
210300300030	COB IP-44	D:190 H:75 Cut:160-170	220-240V	30,000 Hrs	25W	3000K	≥2875	12
210300300031	COB IP-44	D:225 H:75 Cut:200-210	220-240V	30,000 Hrs	35W	6000K	≥3885	12
210300300032	COB IP-44	D:225 H:75 Cut:200-210	220-240V	30,000 Hrs	35W	3000K	≥3885	12

SMD DOWN LIGHT IP-65

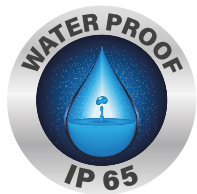

Description:

Milano IP65 waterproof LED Down light adopts high lumen SMD LED, which makes light effect reach 90-100lm/w, PMMA diffuser with even light output. Lamp body IP65 rating designed, can be widely used in indoor and outdoor applications.



SMD DOWN LIGHT IP-65

• Product Features:

1. Up to 70% energy saving compared to standard CFL.
2. IP65 waterproof for indoor and outdoor use.
3. 90° wide beam angle.
4. No UV/IR light.
5. Environment friendly, without Mercury or any other hazardous substances.

• Application:

Commercial, Residential, Hospital, Restaurant, Shopping mall etc.

Note: These lights will be available against project orders.

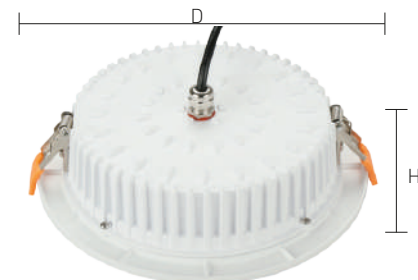



Barcode	Description	Product Size(mm)	Voltage	Lifespan	Power	Color Temp	Lumen(lm)	Std pkg
210300300033	SMD IP-65	D:115 H:38 Cut:95-100	220-240V	30,000 Hrs	13W	6000K	≥1320	24
210300300034	SMD IP-65	D:115 H:38 Cut:95-100	220-240V	30,000 Hrs	13W	3000K	≥1320	24
210300300035	SMD IP-65	D:195 H:46 Cut:175-185	220-240V	30,000 Hrs	25W	6000K	≥2550	12
210300300036	SMD IP-65	D:195 H:46 Cut:175-185	220-240V	30,000 Hrs	25W	3000K	≥2550	12
210300300037	SMD IP-65	D:235 H:54 Cut:205-215	220-240V	30,000 Hrs	35W	6000K	≥3570	12
210300300038	SMD IP-65	D:235 H:54 Cut:205-215	220-240V	30,000 Hrs	35W	3000K	≥3570	12



LED SPOT LIGHTS

LED DIMMABLE/REGULAR SPOT LIGHT



Movable Spot Light



Mini Spot Light



Description:

Milano regular and dimmable spot light has an Aluminium base body which provides high rate of heat sinking capacity, with the beam angle of 40 degrees, it delivers more light on the focused object.

Milano dimmable spot lights have an Aluminium die cut with the latest LED technology. These lights can be dimmed according to the desired mood. These lights are used in cafeterias, restaurants and conference room.

These spot lights are ideal to replace the tradition halogen spot light.



LED DIMMABLE / REGULAR SPOT LIGHT

• Product Features:

1. Attractive appearance.
2. High quality Aluminium provides good heat dissipation for erosion resistance.
3. High quality LED chips, Provides ≥ 80 Lumen per watt, High CRI ≥ 80 , restores the color of the object.
4. Constant current designs, multi protection, no flickering & best in performance.
5. Available in movable cob frame to focus on particular image and object.

• Application:

Commercial, Residential, Hotels, Retail Stores, focusing objects etc.

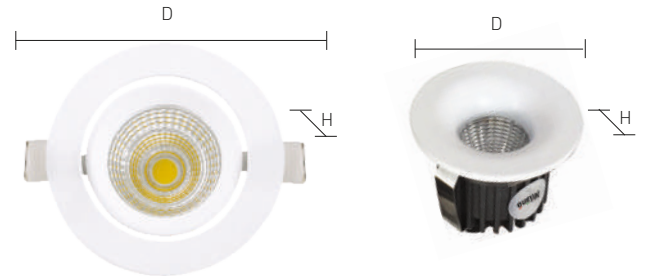



Barcode	Description	Power	Color Temp	Voltage	Product Size(mm)	Lumen(lm)	Std pkg
210302400007	Mini Spotlight-Fix	3W	6000K	220-240V	D:45 H:32 Cut:38	210	100
210302400008	Mini Spotlight-Fix	3W	3000K	220-240V	D:45 H:32 Cut:38	210	100
210302300001	Spotlight-Mov	3W	6000K	220-240V	D:70 H:42 Cut:58	220	100
210302300002	Spotlight-Mov	3W	3000K	220-240V	D:70 H:42 Cut:58	220	100
210302300003	Spotlight-Mov	6W	6000K	220-240V	D:83 H:44 Cut:73	450	50
210302300004	Spotlight-Mov	6W	3000K	220-240V	D:83 H:44 Cut:73	450	50
210302300005	Spotlight-Mov	9W	6000K	220-240V	D:104 H:53 Cut:85	750	50
210302300006	Spotlight-Mov	9W	3000K	220-240V	D:104 H:53 Cut:85	750	50
210302300008	Dimmable Spotlight	6W	6000K	220-240V	D:83 H:44 Cut:73	450	50
210302300009	Dimmable Spotlight	6W	3000K	220-240V	D:83 H:44 Cut:73	450	50
210302300010	Dimmable Spotlight	9W	6000K	220-240V	D:104 H:53 Cut:85	750	50
210302300011	Dimmable Spotlight	9W	3000K	220-240V	D:104 H:53 Cut:85	750	50

LED 3 IN 1 COLOR SPOT LIGHTS

Silver Frame



Gold Frame



White Frame



Coffee Frame

Description:

Milano 3 in 1 color frame spotlight provides the perfect spotlights for residential & commercial installation, these spotlights have glitter surface and are available in Gold, Silver, White & Coffee frames, which suits your interior & give the high Lumen output, These spot lights use latest LED chip technology which change color from warm white to natural white to cool white by switching the light.



LED 3 IN 1 COLOR SPOT LIGHT

• Product Features:

1. Color changing LED spot light for maximum color option.
2. Ideal for residential, commercial, where the light color can be adjusted to suit the task & mood.
3. Decorative glitter frames to match your interiors.
4. Easy installation & zero maintenance.
5. Energy saving up to 90%.
6. Easy to change the tradition halogen spot lights.

• Application:

Residential, commercial, hotel & focusing objects.

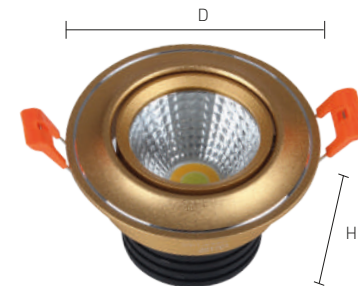



Barcode	Model	Voltage	Power	Color	Lumen(lm)	Product Size(mm)	Std pkg
210301800022	Gold frame	85-265V	7W +7W	3 In 1	620	D:86 H:60 Cut:73	50
210301800023	Silver frame	85-265V	7W +7W	3 In 1	620	D:86 H:60 Cut:73	50
210301800024	Coffee frame	85-265V	7W +7W	3 In 1	620	D:86 H:60 Cut:73	50
210301800025	White frame	85-265V	7W +7W	3 In 1	620	D:86 H:60 Cut:73	50

LED SPOT LIGHTS IP-65

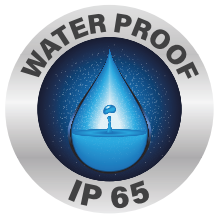

Description:

Milano IP65 rating Spot lights makes it easily usable in bathrooms and soffits. Build to resist water. These water proof Light are modern and stylish feature to any Ceiling. The way they blends into the gypsum and gives a nice downward Light Effects, which is really classy & stunning. These new lights are door to enter a classy and modern world not only for its elegant design But also it replaces the traditional Halogen Down Lights.



LED IP-65 SPOT LIGHTS

• Product Features:

1. The Spot lights uses the technology IP65 rating which prevents from water & dust.
2. Uses upto 90% less energy gives light equivalent to traditional lights by releasing less heat than halogen spot lights.
3. Available in 6000K, 4000K & 3000K
4. Lumen output ≥ 80 which helps to gives more bright to your desired area.
5. IP-65 makes it Ideal to install in Bathroom, Kitchen, Utility area, Laundry area etc

• Application:

Commercial, Residential, Hospital, Restaurant.

Note: These light will be available against project orders.

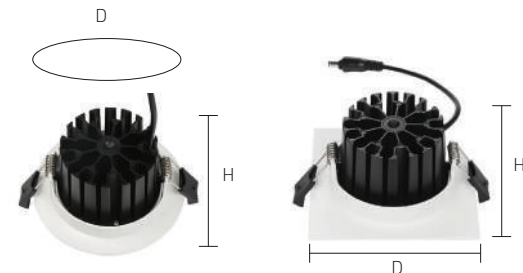



Barcode	Description	Product Size(mm)	Voltage	Power	Lumen(lm)	Color Temp	Std Pkg
210302300022	LED Spot light RD	IP-65 D:80 H:30 Cut:68-72	200-240	5W	≥530	6000K	50
210302300026	LED Spot light RD	IP-65 D:80 H:30 Cut:68-72	200-240	5W	≥530	3000K	50
210302300027	LED Spot light RD	IP-65 D:90 H:39 Cut:75-80	200-240	10W	≥1000	6000K	50
210302300028	LED Spot light RD	IP-65 D:90 H:39 Cut:75-80	200-240	10W	≥1000	3000K	50
210302300029	LED Spot light SQ	IP-65 L:80 H:30 Cut:68-72	200-240	5W	≥530	6000K	50
210302300030	LED Spot light SQ	IP-65 L:80 H:30 Cut:68-72	200-240	5W	≥530	3000K	50
210302300015	LED Spot light SQ	IP-65 L:90 H:39 Cut:75-80	200-240	10W	≥1000	6000K	50
210302300016	LED Spot light SQ	IP-65 L:90 H:39 Cut:75-80	200-240	10W	≥1000	3000K	50

LED COB MR-16 & GU-10



COB MR-16

GU-10



Description:

Save money and energy with the LED COB MR-16 and GU-10 lamps at residential and commercial projects by replacing the traditional halogen lights. These lights consume less power and gives high Lumen output. Energy saving is up to 90%.



LED COB MR-16 & GU-10

• Product Features:

1. Attractive appearance.
2. High quality Aluminium heat spreader and Aluminium reflector.
3. High quality LED COB chips, Provides ≥ 80 Lumen per watt, High CRI ≥ 80 , restores the color of the object.
4. Constant current designs, multi protection, no flickering & best in performance.
5. Life span is 25,000 hrs.
6. Easy installation & zero maintenance.

• Application:

Commercial, Residential, Hotels, Retail Stores, focusing objects etc.

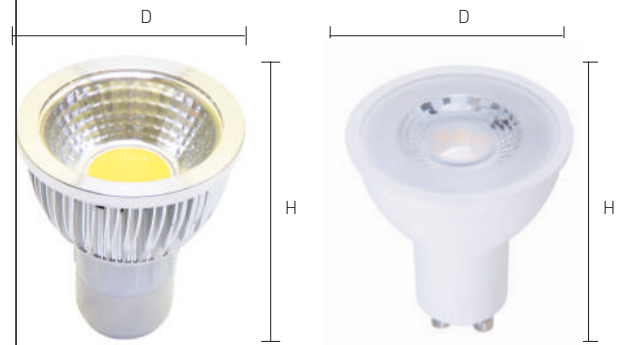



Barcode	Product Size(mm)	Voltage	Power	Life Span	Color Temp	Lumen(lm)	Std pkg
210303100001	D:50 H:62	100-240V	5W	25,000Hrs	6500k	≥420	100
210303100002	D:50 H:62	100-240V	5W	25,000Hrs	3000k	≥420	100
210100800026	D:50 H:56	220-240V	6W	25,000 Hrs	6500k	≥450	200
210100800027	D:50 H:56	220-240V	6W	25,000 Hrs	3500k	≥450	200

LED CANDLE LAMP & BULBS

LED CANDLE LAMP

LED Filament with & without tip candle lamp



G-4

GU-10
Mini Candle Lamp



G-9



Description:

Milano Filament and Candle lights are attractive in appearance with high quality LED chips which has designed to spread the high quality light output for your chandeliers and lighting system.



LED CANDLE LAMP

Product Features:

1. Attractive appearance
2. Easy installation & zero maintenance
3. Gold/ Silver colors provides to match chandelier
4. High quality LED chips for higher Lumen output.

• Application:

1. Commercial, Residential, Hotels, Retail Stores, etc.





Barcode	Description	Power	Cap Base	Size(mm)	Color Temp	Lumen(lm)	Std pkg
210304900011	LED Mini Candle Lamp 3 in 1	3.2W	E-14	D:16 H:53	3in1 color	≥320	100/1000
210303300009	LED Filament Candle Lamp W/Tip	4W	E-14	L:115 D:35	6000k	350LM±5%	100
210303300010	LED Filament Candle Lamp W/Tip	4W	E-14	L:115 D:35	3000k	350LM±5%	100
210303300011	LED Filament Candle Lamp W/O Tip	4W	E-14	L:98 D:35	6000k	350LM±5%	100
210303300012	LED Filament Candle Lamp W/O Tip	4W	E-14	L:98 D:35	3000k	350LM±5%	100
210301100036	LED Candle Lamp G-4	2x1.8W	G-4	L:10 H:37	3000k	≥180	12/24
210301100037	LED Candle Lamp G-4	2x1.8W	G-4	L:10 H:37	6000k	≥180	12/24
210301100038	LED Candle Lamp G-9	2x3.3W	G-9	L:16 H:50	3000k	≥320	12/24
210301100039	LED Candle Lamp G-9	2x3.3W	G-9	L:16 H:50	6000k	≥320	12/24

LED BULBS



Description:

Milano LED bulbs are simply class. These bulbs utilize the latest LED chip to enhance maximum light output with greater Lumen. These bulbs can widely replace CFLs in down lights with a warranty of 1 year.

These ensure even illumination which save energy up to 90% and can also be used for outdoor wall brackets, chandelier and garden lights.



LED BULBS

• Product Features:

1. Compact design
2. Unbreakable.
3. High level of energy efficiency and higher brightness.
4. Quick start, smaller size higher lumen output.
5. 90% energy saving.
6. Easy installation & zero maintenance.

• Application:

Commercial, residential, hotels, hospitals, retail stores, etc.





Barcode	Model	Voltage	Power	Cap Base	Color Temp	Lumen(lm)	Std pkg
210301100022	G45	220-240V	5W	E14	6500k	470	100
210301100024	G45	220-240V	5W	E14	3000k	470	100
210301100023	G45	220-240V	5W	E27	6500k	470	100
210301100025	G45	220-240V	5W	E27	3000k	470	100
210301100012	A55	220-240V	6W	E27	6500k	470	100
210301100013	A55	220-240V	6W	E27	3000k	470	100
210301100014	A55	220-240V	9W	E27	6500k	806	100
210301100015	A55	220-240V	9W	E27	3000k	806	100
210301100016	A65	220-240V	12W	E27	6500k	1055	60
210301100017	A65	220-240V	12W	E27	3000k	1055	60
210301100018	A65	220-240V	15W	E27	6500k	1521	60
210301100019	A65	220-240V	15W	E27	3000k	1521	60
210301100020	A75	220-240V	20W	E27	6500k	1900	36
210301100026	A75	220-240V	20W	E27	3000k	1900	36



STRIP LIGHTS

LED STRIP LIGHTS 2835 & 5050

E-27

Model: 5050
Color: White & Warm White



Model: 5050
Color: RGB

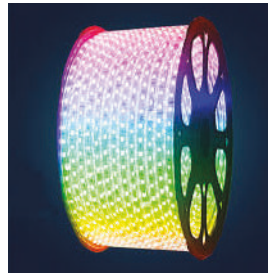

Description:

Milano LED strip lights are unique in design with soft flexible PVC housing with latest LED chip technology. The light output is high with a lifetime nearly up to 25,000 hrs.

With wide beam angle, this strip lights are ideal for sophisticated ceiling design and interiors.



LED STRIP LIGHTS 2835 & 5050

Product Features:

1. Available in 5050 & 2835 model
2. Anti UV, PVC material to minimize fire risk
3. 120° degree beam angle
4. High quality light output
5. Sleek and flexible which makes easy installation for complicated interiors

Application:

1. Commercial, Residential, Hotel etc.

Model: 2835

Colors: White, Warm White, Red, Blue & Green

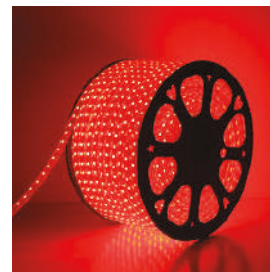



Barcode	Model	Power	Voltage	Color Temp	Lumen(lm)	No.Chips	Std pkg
210301000002	High Power Strip Light 5050	8W	220V-240V	6000k	450/m	60	50mtr
210301000003	High Power Strip Light 5050	8W	220V-240V	2700k	450/m	60	50mtr
210301000009	High Power Strip Light 5050	8W	220V-240V	RGB	450/m	60	50mtr
210301000004	Double Chip Strip Light 2835	11W	220V-240V	6000k	600/m	180	50mtr
210301000005	Double Chip Strip Light 2835	11W	220V-240V	2700k	600/m	180	50mtr
210301000006	Double Chip Strip Light 2835	11W	220V-240V	Red	600/m	180	50mtr
210301000007	Double Chip Strip Light 2835	11W	220V-240V	Green	600/m	180	50mtr
210301000008	Double Chip Strip Light 2835	11W	220V-240V	Blue	600/m	180	50mtr
210303600007	Power Chord 5050 RGB	N/A	N/A	N/A	N/A	N/A	1 Pcs
210303600002	Power Chord 5050	N/A	N/A	N/A	N/A	N/A	1 Pcs
210303600003	Power Chord 2835	N/A	N/A	N/A	N/A	N/A	1 Pcs
210303600004	Accessories 5050	N/A	N/A	N/A	N/A	N/A	1 Pcs
210303600005	Accessories 2835	N/A	N/A	N/A	N/A	N/A	1 Pcs

LED T5 LIGHTS

LED T5 FITTING



Description:

Milano LED T5 lights are energy efficient & long lasting these lights are energy saving replacement for old fluorescent lights. They are ideal for gypsum, ceiling interior cabinet lighting, display lighting, warehouse racking, shops, schools or homes, these surface mounted fittings are in different length, watts & colors to suit any application.



LED T5 FITTING

• Product Features:

1. Saves energy more than 90%.
2. Adopts constant circuit design, new type of cover material for multi protection.
3. CRI ≥ 80 , restores true color of the object.
4. High light transmittance acrylic cover, soft & light, uniform & non glare.

• Application:

1. Under cabinet lighting.
2. Showroom (showcases display areas, sales counter etc.)
3. Kitchen & bathrooms (mirror lights).
4. Widely used in commercial & residential buildings.

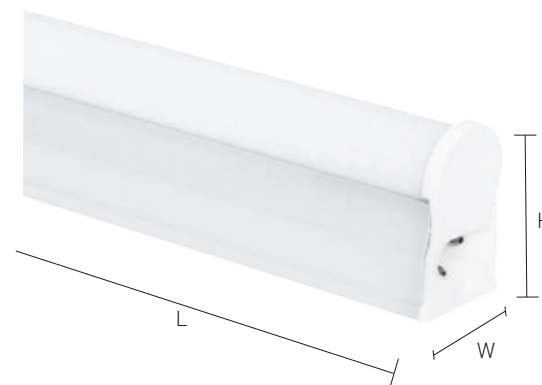



Barcode	Product Size(mm)	Voltage	Power	Life Span	Color Temp	Lumen(lm)	Std pkg
210302900003	L:600 H:3.3 W:2.3	220-240V	9W	25,000Hrs	6500k	520	30
210302900004	L:600 H:3.3 W:2.3	220-240V	9W	25,000Hrs	3000k	520	30
210303700001	L:900 H:3.3 W:2.3	220-240V	12W	25,000Hrs	6500k	700	30
210303700002	L:900 H:3.3 W:2.3	220-240V	12W	25,000Hrs	3000k	700	30
210303000005	L:1200 H:3.3 W:2.3	220-240V	20W	25,000Hrs	6500k	1600	30
210303000006	L:1200 H:3.3 W:2.3	220-240V	20W	25,000Hrs	3000k	1600	30

RECHARGEABLE EMERGENCY LIGHT



Description:

Milano rechargeable emergency light has 1X8W fluorescent tube, Needs the charging time of 13-15hrs & provides the output light of 2-3hrs

RECHARGEABLE EMERGENCY LIGHT

• Product Features:

1. 1X8W fluorescent tube
2. 3.6V1500mAh Ni_cd battery
3. Emergency light out of 3 hours,
4. PCB designed with transformer to protect the batteries for over charged and over discharged time

• Application:

1. Residential/Commercial uses

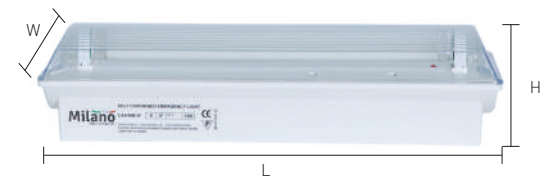

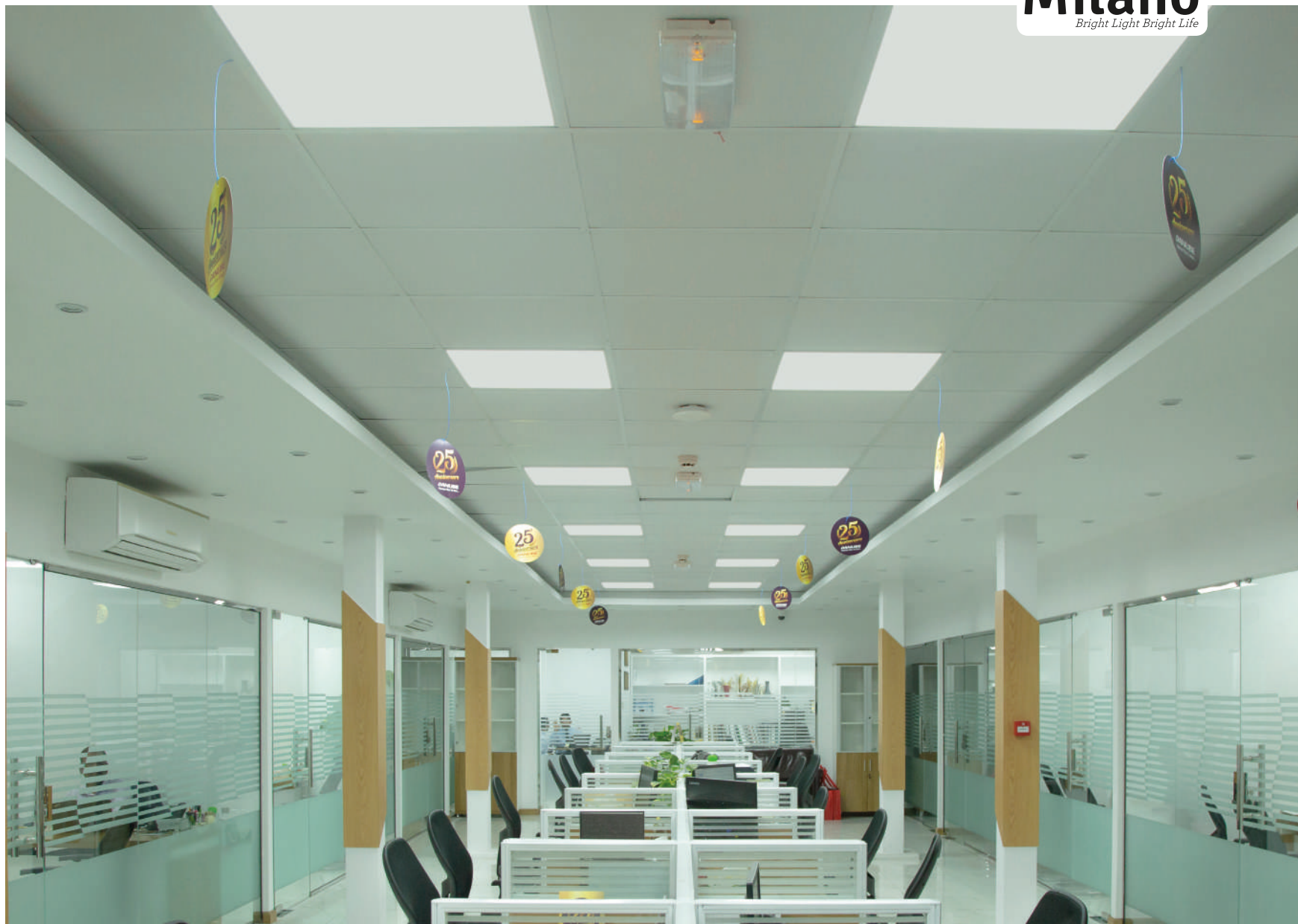

Barcode	Description	Product Size(mm)	Voltage	Power	Lumen(lm)	Color Temp	Std Pkg
210100200201	Emergency Light	L:368 W:105 H:85	220-240V	1x8W	≥1000	6500K	10

SENSORS



IR Surface Sensor



IR Ceiling Sensor



Description:

Milano Sensors, Switches on/off the lights automatically when someone enters/leaves the room, these sensor switch with complete 360 degree detection angle. Enables connected lights to switch on automatically & then stays on until the person leaves the room and then switches itself off when the room is unoccupied,

These sensors reflect the latest development in interior lighting technology and provide close to zero energy wastage in terms of lights being On unnecessarily with ability to adjust the timing 10 sec to 15 minutes and adjust the level of ambient light intensity at which the device operated.



SENSORS

• Product Features:

1. Detection Angle:360 degree
2. Detection distance:Max 6M
3. Adjustable Lux
4. Sleek & elegant design suitable for surface & concealed ceiling.

• Application:

1. Balcony, corridor, stairs etc.

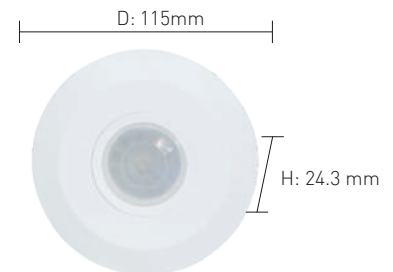



Barcode	Description	Installation Height	Detection Distance	Ambient light	Ambient light	Std Pkg
210100500098	Surface Sensor	2.2 - 4 Mtrs	6 Mtrs Max	3-2000LUX (Adjustable)	1000W for LED	50
210100500099	Ceiling Sensor	2.2 - 4 Mtrs	6 Mtrs Max	3-2000LUX (Adjustable)	1200W for LED	50



MIRROR LIGHTS

DECORATIVE LED MIRROR LIGHTS

210304200006



210304200008



210304200007

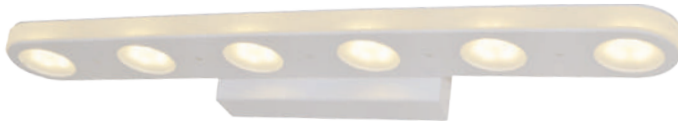

210304200004



Description:

Milano decorative LED mirror light gives your home an instant lift by providing extra light. It can make every day looks like applying makeup and shaving easier.

The natural light (4200k) is brighter, bigger and more attractive and it makes ideal to replace the traditional florescent tube lights.



DECORATIVE LED MIRROR LIGHTS

Product Features:

1. Uses latest LED technology
2. Classy and elegant design
3. Natural lights provides you the perfect match for your interior
4. Energy saving up to 90%
5. Easy installation and maintenance free
6. IP-20

Application:

1. Bathrooms & Photo frames.

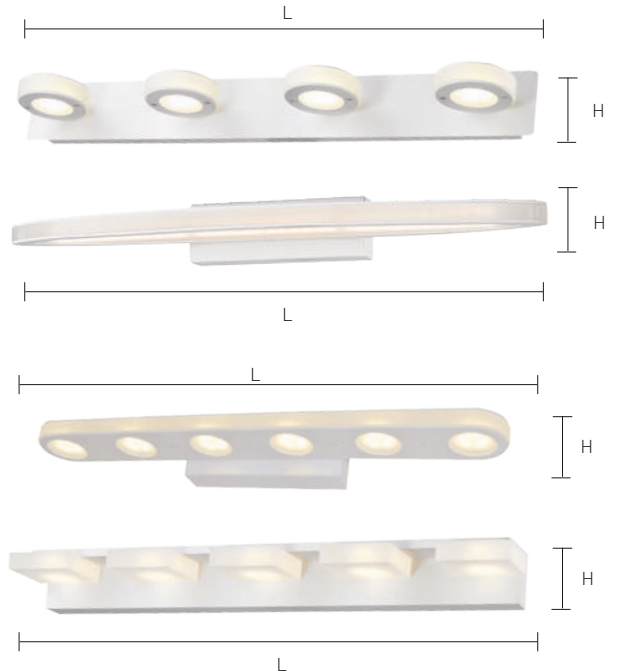



Barcode	Description	Product Size(mm)	Voltage	Power	Lumen(lm)	Color Temp	Std Pkg
210304200006	LED Mirror Circle	L:660 W:130 H:60	85-265V	12W	840	4000K	10
210304200008	LED Mirror Oval	L:595 W:100 H:50	85-265V	18W	1260	4000K	10
210304200007	LED Mirror Dotted	L:575 W:110 H:45	85-265V	18W	1260	4000K	10
210304200004	LED Mirror Cube	L:530 W:105 H:50	85-265V	15W	1050	4000K	10

LED MIRROR LIGHTS

210304200001



210304200002



210304200009



210304200005



Description:

Milano LED mirror light are designed for high quality light output, which utilizes the latest LED chip technology. This simple and classy design can match your interiors giving a bright view on mirrors and wall.

These are ideal range to replace the traditional florescent lamp and are easy to install.



LED MIRROR LIGHTS

• Product Features:

1. Attractive and elegant design
2. High Lumen uses LED chip technology
3. Cool white provides brighter view
4. Energy saving up to 90%
5. Easy installation and maintenance free
6. IP-20

• Application:

1. Bathrooms & Photo frames.

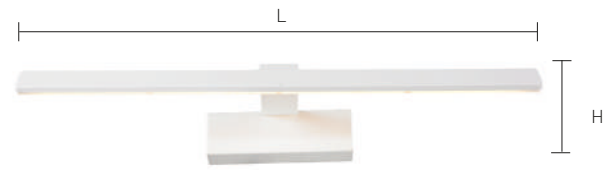
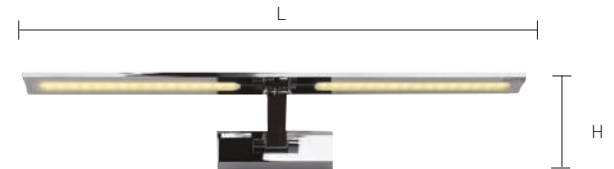



Barcode	Description	Product Size(mm)	Voltage	Power	Lumen(lm)	Color Temp	Std Pkg
210304200002	LED Mirror Light Bold	L:536 W:38 H:55	220-240V	14W	1000	6500K	20
210304200001	LED Mirror Light Twist	L:579 W:35 H:78	220-240V	10W	800	6500K	12
210304200009	LED Mirror Light Chrome	L:615 W:110 H:50	220-240V	16W	1120	4000K	10
210304200005	LED Mirror Light Flap	L:535 W:175 H:50	220-240V	18W	1260	4000K	10



HIGHBAY & CEILING LIGHTS

LED Highbay Lighting



100W



150W



200W

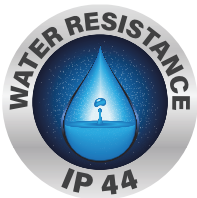

Description:

Milano High bay lights provide high quality lights with lowest consumption on power. These lights give uniform light output. With the beam angle of 120 degree these lights provide superior light distribution.



LED Highbay Lighting

Product Features:

1. Housing Aluminium die- cast
2. IP-44
3. Life Span 25,000 hrs
4. High Lumen output

Application:

1. Warehouses, Showrooms, Factories, Shopping malls etc.





Barcode	Product Size(mm)	Voltage	Lifespan	Power	Color Temp	Lumen(lm)	Std pkg
210301300030	D:450 H:350	85-265V	25,000 Hrs	100W	6500k	≥9000	1
210301300029	D:500 H:350	85-265V	25,000 Hrs	150W	6500k	≥13500	1
210301300028	D:500 H:350	85-265V	25,000 Hrs	200W	6500k	≥18000	1

LED IP-54/65 CEILING LIGHT



Without Sensor (IP 54)



With Sensor (IP 54)



Squire (IP 65)



Omega (IP 54)



Description:

Milano ceiling lights are designed to provide the lightings for the outdoor usage with IP-54 ratings. These lights comes in two versions (with sensor and without sensor).

The sensor lights will turn on the light automatically when you pass by and turn off automatically when you leave off. These sensor lights can be adjusted the time delay, lux level of the light and the detection range as per your requirement.



LED IP-54 CEILING LIGHT

• Product Features:

1. Energy efficient, Saves upto 90% Energy in comparison of traditional lights
2. Sleek & elegant design
3. Eco friendly, No hazardous substances like mercury or lead. Pollution free, NO IR, UV
4. Super bright with high lumen output,
5. Easy to install & can replace the traditional lamp with CFL holders

LED IP - 54 WITH SENSOR

• Sensor Features:

1. Detection angle 360
2. Detection range 1-8 mtr (radii) adjustable
3. Time setting 10s-12 mins
4. Lux setting 10-2000 lux
5. Installation height 2.5-3.5m

• Application:

Bathrooms, Kitchens, Balconies, Lobbies, Offices, Store rooms, Passages, etc.

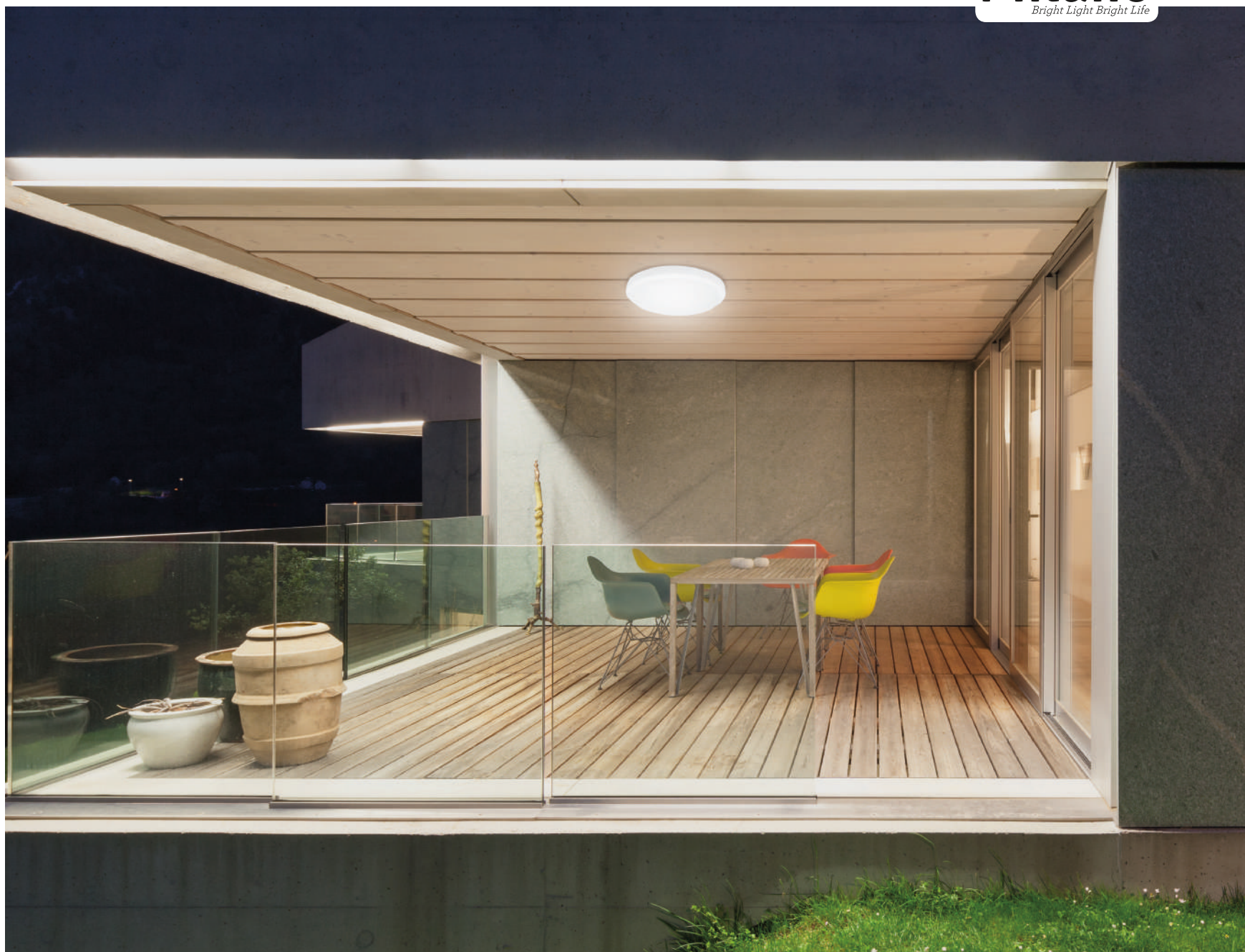

Barcode	Description	Product Size(mm)	Voltage	Power	Lumen(lm)	Color Temp	Std Pkg
210304400005	Ceiling Light W/O Sensor	D:305 H:84	220-240V	17W	≥1300	6500K	8
210304400006	Ceiling Light With Sensor	D:305 H:84	220-240V	17W	≥1300	6500K	8
210304400003	Square Ceiling Light	L:290 H:290 W:50	220-240V	20W	≥1400	6500K	6
210304400004	Square Ceiling Light	L:290 H:290 W:50	220-240V	20W	≥1400	3000K	6
210304700024	Omega Ceiling Light	D:330 H:55	220-240V	24W	≥2050	6000K	12



WATER PROOF FITTINGS

LED TRI-PROOF FITTINGS



Description:

Milano IP-65 LED Tri-proof light are innovative light which can be used for multipurposes like, Batten fitting for indoor use, water proof light as parking areas or super markets/ industrial purpose. Due to its sleek & elegant design, it can be used indoor & out door. With an extra long life rating of 300,000 hours, they can easily replace your existing light and never replace again. These LED lights are easy for installation & maintenance.



LED TRI-PROOF FITTINGS IP-65

• Product Features:

1. Uniform light output, bright and comfortable, alleviating eye fatigue, wide beam angle.
2. Professional waterproof technology IP65 to ensure safety and reliability
3. These LED lights provide high lumens at daylight white 6000k with high efficiency of 90-100 lumen per watt.
4. Can be used as ceiling mount or wall mount
5. Highly durable, material used is PC cover & housing

• Application:

Parking lot, airport, tunnel, gallery, gas station, garages, warehouses, factories, shops, or utility rooms, replaces traditional tube fixtures.

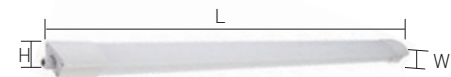



Barcode	Description	Power	Product Size(mm)	Voltage	Life Span	Color Temp	Lumen(lm)	Std pkg
210100200180	LED Tri-Proof Fitting	20W	L:600 H:51 W:80	220-240V	25,000 Hrs	6000K	≥1800	12
210100200212	LED Tri-Proof Fitting	20W	L:600 H:51 W:80	220-240V	25,000 Hrs	3000K	≥3500	12
210100200181	LED Tri-Proof Fitting	40W	L:1200 H:51 W:80	220-240V	25,000 Hrs	6000K	≥3600	8
210100200213	LED Tri-Proof Fitting	40W	L:1200 H:51 W:80	220-240V	25,000 Hrs	3000K	≥3600	8



FLOOD LIGHTS

360 D LED SMD FLOOD LIGHT



Description:

Milano SMD flood lights are a great step forward in the lighting industry. The energy consumption is much lower & performance is often higher than that of all other widely used traditional halogen type fixtures, these flood lights can be mounted to an any surface and can be the direction of light to 360 degree.

These flood lights are slim with heavy Aluminium die-cast & can be used anywhere, both in commerce, residential environment, Parking lots, backyards, walkway & industrial space etc.



360 D LED SMD FLOOD LIGHT

Product Features:

1. Heavy Aluminium alloy body.
2. High quality SMD LED.
3. Beam angle-150D.
4. Led Luminous efficiency greater than or equal to 90 lm /W.
5. IP-65
6. Life Span: More than 25,000Hrs.
7. Easy installation & zero maintenance.
8. Built in Constant Current & water proof driver.

Application:

1. Residential, Commercial, Garden outdoor area





Barcode	Model	Product size(mm)	Voltage	Power	Color Temp	Lumen(lm)	Std pkg
210300400036	360D SMD	L:120 W:33 H:95	85-265V	10W	6000K	900	40
210300400037	360D SMD	L:120 W:33 H:95	85-265V	10W	3000K	900	40
210300400038	360D SMD	L:170 W:35 H:127	85-265V	20W	6000K	1800	20
210300400039	360D SMD	L:170 W:35 H:127	85-265V	20W	3000K	1800	20
210300400040	360D SMD	L:215 W:38 H:157	85-265V	30W	6000K	2700	10
210300400041	360D SMD	L:215 W:38 H:157	85-265V	30W	3000K	2700	10
210300400050	SMD	L:181 W:43 H:220	85-265V	30W	RGB	2700	10
210300400042	360D SMD	L:252 W:43 H:190	85-265V	50W	6000K	4500	8
210300400043	360D SMD	L:252 W:43 H:190	85-265V	50W	3000K	4500	8
210300400044	360D SMD	L:334 W:55 H:258	85-265V	100W	6000K	9000	5
210300400045	360D SMD	L:334 W:55 H:258	85-265V	100W	3000K	9000	5
210300400046	360D SMD	L:380 W:66 H:280	85-265V	150W	6000K	13500	4
210300400047	360D SMD	L:380 W:66 H:280	85-265V	150W	3000K	13500	4
210300400048	360D SMD	L:450 W:80 H:330	85-265V	200W	6000K	18000	3
210300400049	360D SMD	L:450 W:80 H:330	85-265V	200W	3000K	18000	3
210300400052	360D SMD	L:430 W:78 H:400	85-265V	300W	6000K	27000	2

LED RECHARGABLE FLOOD LIGHT



Description:

Milano LED rechargeable portable cordless lights are suitable for photographers, tradesmen, late night mechanics or setting up a outdoor desert camping.

These lights can also be used around the house for emergency in case of power failure.



LED RECHARGEABLE FLOOD LIGHT

• Product Features:

1. Housing Aluminium die-casting & toughened glass.
2. IP-54.
3. Battery-18650 lithium battery.
4. Sleek & elegant shape, easy to carry.
5. Beam angle: 120°

• Application:

Outdoor Camping, emergency light, work station, etc.





Barcode	Description	Power	Product Size(mm)	Color	Charging Time	Discharging Time	Std pkg
210300600001	LED Rechargeable Flood Light	10W	L:135 H:265	6000K	3Hrs	4Hrs	20
210300600002	LED Rechargeable Flood Light	20W	L:184 H:298	6000K	6Hrs	4Hrs	10
210300400035	LED Rechargeable Flood Light	50W	L:244 H:392	6000K	10Hrs	4Hrs	6



OUTDOORWALL BRACKETS & WALL LIGHTS

LED WALL BRACKETS



50-50



Full Oval



Description:

Milano LED brackets comes with high efficiency LED which is designed to upgrade the traditional fluorescent lamps. Easy to install and maintenance free without worrying about changing lamps.



LED WALL BRACKETS

• Product Features:

1. IP-65 polycarbonate LED bulkhead
2. Polycarbonate body with diffuser
3. Aesthetic black border
4. Wall or ceiling mounting
5. Real wiring allows easy installation
6. Diffuser evenly distributes light source

• Application:

Balcony, corridor, stairs etc.





Barcode	Description	Product Size(mm)	Voltage	Power	Lumen(lm)	Color Temp	Std Pkg
210100200174	LED Wall bracket Full Oval IP-65	L:200 H:290 W:100	220-240V	12W	≥840	6500K	12
210100200175	LED Wall bracket Full Oval IP-65	L:200 H:290 W:100	220-240V	12W	≥840	3000K	12
210100200178	LED Wall bracket 50-50 IP-54	L:165 H:281 W:99	220-240V	15W	≥750	6500K	12
210100200179	LED Wall bracket 50-50 IP-54	L:165 H:281 W:99	220-240V	15W	≥750	3000K	12

LED MINI WALL BRACKETS



Delta



Omega



Full Grill



Description:

Milano LED mini wall bracket are powerful and energy efficient to alternative to standard bulkhead utility Lumen. Designed specifically for LED technology, their impact resistant and polycarbonate housing provides a superior interior making it ideal for residential and commercial application.



LED MINI WALL BRACKETS

• Product Features:

1. IP-54
2. Small and compact design
3. Mountable for wall and ceiling
4. Integrated driver
5. Rear wiring allows easy installation
6. Polycarbonate housing

• Application:

Balcony, corridor, stairs etc.

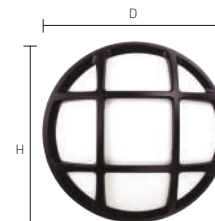



Barcode	Description	Product Size(mm)	Voltage	Power	Lumen(lm)	Color Temp	Std Pkg
210304700018	LED Wall Bracket Delta	L:210 H:42 W:105	220V-240V	14W	≥980	6000K	24
210304700019	LED Wall Bracket Delta	L:210 H:42 W:105	220V-240V	14W	≥980	3000K	24
210304700020	LED Wall Bracket Omega	D:190 H:48	220V-240V	14W	≥980	6000K	24
210304700021	LED Wall Bracket Omega	D:190 H:48	220V-240V	14W	≥980	3000K	24
210100200170	LED Wall Bracket with Full grill	H:73 D:170	220-240V	8W	≥400	6500K	20
210100200171	LED Wall Bracket with Full grill	H:73 D:170	220-240V	8W	≥400	3000K	20

LED OUTDOOR WALL BRACKET



210304300002

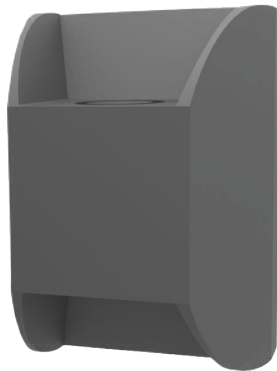

210304300005



210304300003



Description:

Milano LED outdoor lights are designed with a heavy die-cast Aluminium body. These shapes are unique & designed to give wide spread light output. These wall brackets give you a option for multiple setting & designing light output to your walls.



LED OUTDOOR WALL BRACKET

• Product Features:

1. High Quality Aluminium Die cast.
2. IP-54.
3. Easy Installation & Zero Maintain.
4. LED Chip For Higher Lumen Output.
5. Shining Black Body.
6. Energy Saving Up to 90%.

• Application:

Architecture outdoor elevation.

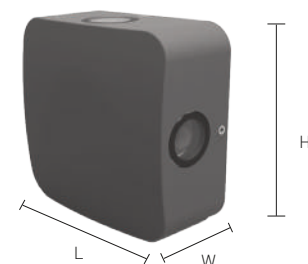
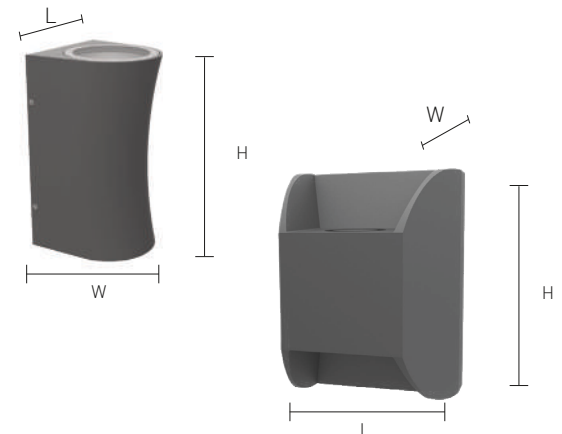



Barcode	Description	Power	Voltage	Product Size(mm)	Color Temp	Lumen(lm)	Std pkg
210304300003	4 Way Wall Light	4x1W	90-260V	L:110 H:110 W:50	3000K	360	20
210304300002	Wall Light Up & Down Bend	2x6W	90-260V	L:105 H:200 W:104	3000K	1200	8
210304300005	Wall Light Up & Down Spread	2x3W	90-260V	L:88 H:124 W:78	3000K	600	20

LED OUTDOOR WALL BRACKET

210304300001



210304300007



210304300006



210304300004



Description:

Milano Up & Down lights are in designed cylindrical shapes with high quality Aluminium body showing a soft & shining black/white appearance. These lights will guarantee the perfect light pattern for outdoor walls, which are suitable to replace the traditional halogen wall lights.



LED OUTDOOR WALL BRACKET

• Product Features:

1. High quality Aluminium die cast.
2. IP-54.
3. Easy installation & zero maintain.
4. LED chip for higher Lumen output.
5. Shining black body.
6. Energy saving up to 90%.

• Application:

Architecture outdoor elevation.

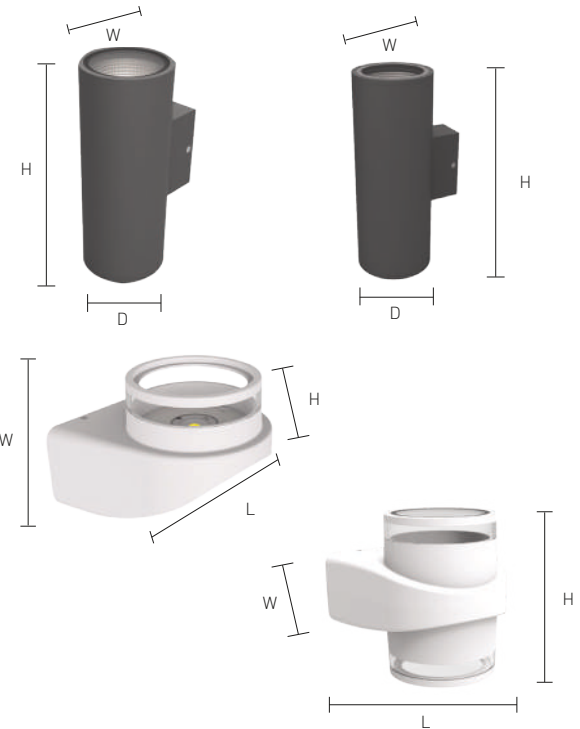

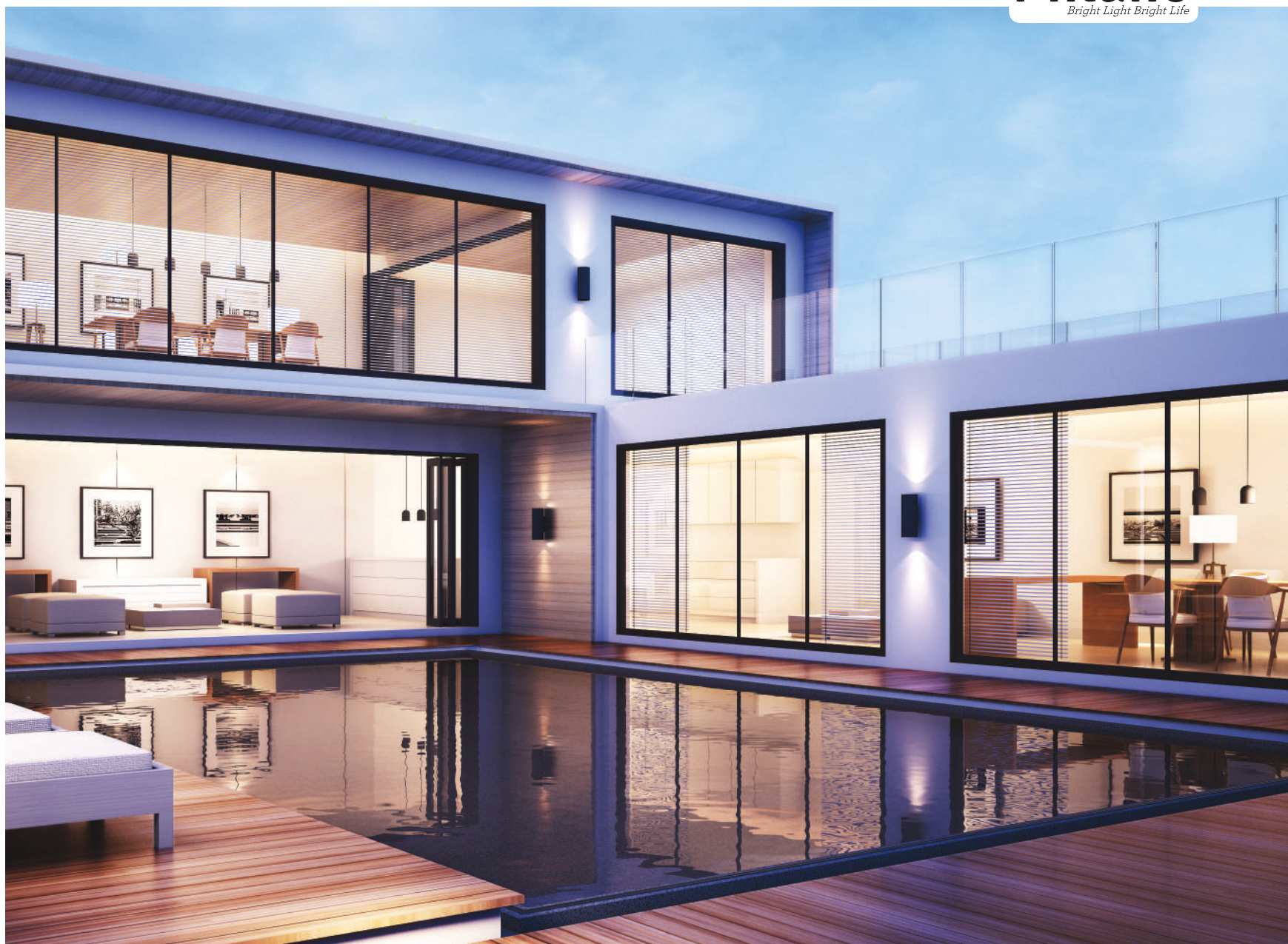

Barcode	Description	Power	Voltage	Product Size(mm)	Color Temp	Lumen(lm)	Std pkg
210304300001	Shoot Up & Down Wall Light Big	2x12W	90-260V	L:108 H:260 W:147	3000K	1600	10
210304300007	Shoot Up & Down Wall Light Small	2x8W	90-260V	L:90 H:220 W:130	3000K	1200	10
210304300006	Wall Light Pop Up & Down	2x6W	90-260V	L:140 H:140 W:126	3000K	1200	8
210304300004	Wall Light Pop Up	1x8W	90-260V	L:140 H:103 W:127	3000K	800	8



UNDER GROUND STEP & SPIKE LIGHTS

LED UNDERGROUND LIGHTS



Description:

Milano Underground high power COB LED chips enables a solid-state lightning solution that is more effective, reliable and long lasting than ever before possible.

Designed with high-quality stainless steel frame that can with stand outdoor conditions.



LED UNDERGROUND LIGHTS

• Product Features:

1. High quality stainless steels and die casting Aluminium body
2. Easy installations and zero maintenance
3. Available in 3W, 6W, 9W,12W & 30W
4. Choice of 2 colors: 6500k and 3000k
5. IP-65 protection
6. High CRI ≥80
7. Beam angle 30°

• Application:

Outdoor garden. path way, swimming pool area, etc.





Barcode	Model	Input Voltage	Product Size(mm)	Power	Color	Lumen(lm)	Std pkg
210302800005	LED Underground Light	220-240V	D:65 L:80	3W	6000K	210	50
210302800006	LED Underground Light	220-240V	D:65 L:80	3W	3000K	210	50
210302800007	LED Underground Light	220-240V	D:80 L:90	6W	6000K	420	50
210302800008	LED Underground Light	220-240V	D:80 L:90	6W	3000K	420	50
210302800009	LED Underground Light	220-240V	D:100 L:90	9W	6000K	630	20
210302800010	LED Underground Light	220-240V	D:100 L:90	9W	3000K	630	20
210302800011	LED Underground Light	220-240V	D:120 L:90	12W	6000K	840	20
210302800012	LED Underground Light	220-240V	D:120 L:90	12W	3000K	840	20
210304300036	LED Under ground light	220-240V	D:200 H:110	30W	6000K	1950	8
210304300037	LED Under ground light	220-240V	D:200 H:110	30W	3000k	1950	8

LED CONCEALED STEP LIGHTS



Description:

Lighting a stairway always improves safety and adds an inviting glow to your space. Milano LED step lights can be used to enhance your landscape or simply to feel more secure knowing your staircase is brightly lit.



LED CONCEALED STEP LIGHTS

• Product Features:

1. High Aluminium die cut body
2. Easy installation and zero maintenance
3. High quality SMD LED
4. Available in white, warm white and blue color
5. IP-45 protection for square type and IP-20 for round type
6. Beam angle 30°

• Application:

Staircase, directional guides, garden area etc..

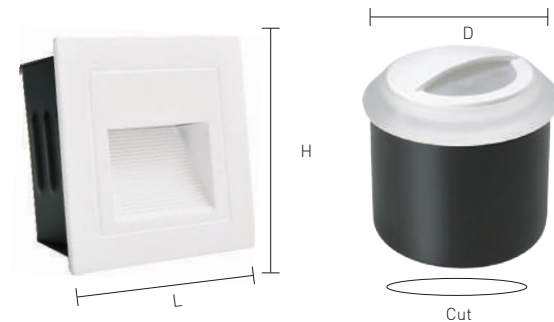



Barcode	Product Size	Voltage	Power	Product Size(mm)	Color Temp	Lumen(lm)	Std pkg
210304100004	LED Concealed Step Light RD	220-240V	3W	D:60 Cut:55	6000K	150	100
210304100005	LED Concealed Step Light RD	220-240V	3W	D:60 Cut:55	3000K	150	100
210304100006	LED Concealed Step Light RD	220-240V	3W	D:60 Cut:55	Blue	150	100
210304100001	LED Concealed Step Light SQ	220-240V	3W	L:85 H:85 Cut:70	6000K	210	100
210304100002	LED Concealed Step Light SQ	220-240V	3W	L:85 H:85 Cut:70	3000K	210	100
210304100003	LED Concealed Step Light SQ	220-240V	3W	L:85 H:85 Cut:70	Blue	210	100
210301900003	LED Stair Light With Grill	220-240V	3W	L:110 H:55 W:45	6000K	150	50
210301900004	LED Stair Light With Grill	220-240V	3W	L:110 H:55 W:45	3000K	150	50
210301900007	LED Stair Light With Grill	220-240V	5W	L:170 H:55 W:70	6000K	250	25
210301900008	LED Stair Light With Grill	220-240V	5W	L:170 H:55 W:70	3000K	250	25

LED SPIKE LIGHT

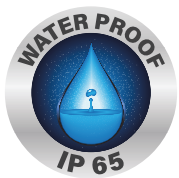

Description:

Milano LED spike light are highly weather resistance. These are the spot lights supplied with ground spike and are ideal in any garden or outdoor space to highlight plants, trees, garden borders & specific features such as statues. The life span of there lights are much longer than a standard halogen lamp, which saves time & money spent on maintenance.



LED SPIKE LIGHT

• Product Features:

1. High quality die-cast Aluminium.
2. IP-65.
3. COB led to provide higher Lumen output.
4. Energy saving up to 90%.
5. Easy installation & zero maintenance.

• Application:

ILLuminate, trees, plant, water fountain, showpiece, statues.





Barcode	Description	Power	Voltage	Color	Product Size(mm)	Lumen(lm)	Std Pkg
210302700001	LED Spike Light	5W	220-240V	3000K	D:65 H:280	350	50
210302700002	LED Spike Light	5W	220-240V	Green	D:65 H:280	350	50
210302700003	LED Spike Light	5W	220-240V	Red	D:65 H:280	350	50
210302700004	LED Spike Light	5W	220-240V	Blue	D:65 H:280	350	50
210302700017	LED Spike Light	12W	220-240V	3000k	D:80 H:300	≥840	20
210302700018	LED Spike Light	12W	220-240V	Green	D:80 H:300	≥840	20
210302700019	LED Spike Light	12W	220-240V	Red	D:80 H:300	≥840	20
210302700020	LED Spike Light	12W	220-240V	Blue	D:80 H:300	≥840	20



STYLISH **SWITCHES** WITH EFFICIENT
HOME CONTROL SOLUTIONS!



BRUSHED GOLD



Std Pkg
8/80

16A 1 Gang 1 Way

210800100018

16A 1 Gang 2 Way

210800100019



Std Pkg
8/80

16A 2 Gang 1 Way

210800100020

16A 2 Gang 2 Way

210800100021



Std Pkg
8/80

16A 3 Gang 1 Way

210800100022

16A 3 Gang 2 Way

210800100023



Std Pkg
8/80

10A 4 Gang 1 Way

210800100024

10A 4 Gang 2 Way

210800100025



Std Pkg
30/300

Single Blank Plate

210800500005



Std Pkg
8/80

Bell Switch

210800200004



Std Pkg
8/80

10A 1 Gang Intermediate

210800100041



Std Pkg
8/80

20A Flex Outlet

210100300302



Std Pkg
6/60

45A Flex Outlet

210100300305



Std Pkg
8/80

15A Switch Socket

210800600012

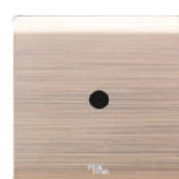

Std Pkg
8/80

TV Socket

210800800005



Std Pkg
8/80

TV & Satellite Socket

210200100057



Std Pkg
8/80

Satellite Socket

210800800006



Std Pkg
8/80

Dual RJ45 Socket

210100300292

Telephone + Computer Socket

210100300259



Std Pkg
8/80

Telephone Socket

210100300256



Std Pkg
8/80

Computer Socket RJ45 (Old)

210802300003

Computer Socket CAT6 (New)

210802300006



Std Pkg
6/60

630W Light Dimmer

210801000005

300W Fan Dimmer

210801000008



Std Pkg
8/80

20A DP With Neon

210800300006



Std Pkg
8/80

45A DP With Neon

210800300007



Std Pkg
8/80

16A Universal Socket

210100300315



Std Pkg
8/80

16A Universal Socket With USB

210100300318



Std Pkg
8/80

13A Socket With Neon

210800600007



Std Pkg
5/50

13A 2 Gang Socket Neon

210800600008



Std Pkg
5/50

Cooker Unit

210800400004



BRUSHED SILVER



Std Pkg
8/80

16A 1 Gang 1 Way

210800100026

16A 1 Gang 2 Way

210800100027



Std Pkg
8/80

16A 2 Gang 1 Way

210800100028

16A 2 Gang 2 Way

210800100029



Std Pkg
8/80

16A 3 Gang 1 Way

210800100030

16A 3 Gang 2 Way

210800100031



Std Pkg
8/80

10A 4 Gang 1 Way

210800100032

10A 4 Gang 2 Way

210800100033



Std Pkg
30/300

Single Blank Plate

210800500006



Std Pkg
8/80

Bell Switch

210800200005



Std Pkg
8/80

10 A 1 Gang Intermediate

210800100042



Std Pkg
8/80

20A Flex Outlet

210100300303



Std Pkg
6/60

45A Flex Outlet

210100300306



Std Pkg
8/80

15A Switch Socket

210800600013



Std Pkg
8/80

TV Socket

210800800007



Std Pkg
8/80

TV & Satellite Socket

210200100058



Std Pkg
8/80

Satellite Socket

210800800008



Std Pkg
8/80

Computer Socket RJ45 (Old)

210802300004

Computer Socket CAT6 (New)

210802300007



Std Pkg
8/80

Dual RJ45 Socket

210100300293

Telephone + Computer Socket

210100300258



Std Pkg
8/80

Telephone Socket

210100300257



Std Pkg
6/60

630W Light Dimmer

210801000006

300W Fan Dimmer

210801000009



Std Pkg
8/80

20A DP With Neon

210800300008



Std Pkg
8/80

45A DP With Neon

210800300009



Std Pkg
8/80

16A Universal Socket

210100300316



Std Pkg
8/80

16A Universal Socket With USB

210100300319



Std Pkg
8/80

13A Socket With Neon

21080060009



Std Pkg
5/50

13A 2 Gang Socket Neon

210800600010



Std Pkg
5/50

Cooker Unit

210800400005



METAL PLATE WHITE



Std Pkg
8/80

16A 1 Gang 1 Way

210800100010

16A 1 Gang 2 Way

210800100011

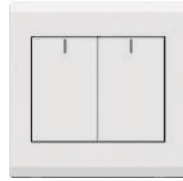

Std Pkg
8/80

16A 2 Gang 1 Way

210800100012

16A 2 Gang 2 Way

210800100013



Std Pkg
8/80

16A 3 Gang 1 Way

210800100014

16A 3 Gang 2 Way

210800100015

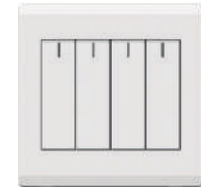

Std Pkg
8/80

10A 4 Gang 1 Way

210800100016

10A 4 Gang 2 Way

210800100017



Std Pkg
20/200

Blank Plate

210800500004



Std Pkg
8/80

Bell Switch

210800200003



Std Pkg
8/80

10A Intermediate Switch

210800100040



Std Pkg
8/80

20A Flex Outlet

210100300304



Std Pkg
6/60

45A Flex Outlet

210100300307



Std Pkg
8/80

15A Switch Socket

210800600011



Std Pkg
8/80

TV Socket

210800800003



Std Pkg
8/80

TV & Satellite Socket

210200100056



Std Pkg
8/80

Satellite Socket

210800800004

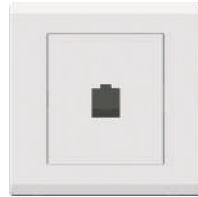

Std Pkg
8/80

Telephone Socket

210100300289



Std Pkg
8/80

Telephone + Computer Socket

210100300260
Dual RJ45 Socket
210100300294

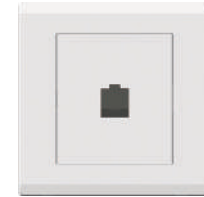

Std Pkg
8/80

Computer Socket RJ45 (Old)

210802300002
Computer Socket CAT6 (New)
210802300008



Std Pkg
6/60

630W Light Dimmer

210801000004

300W Fan Dimmer Switch

210801000007



Std Pkg
8/80

20A DP with Neon

210800300004



Std Pkg
8/80

45A DP with Neon

210800300005



Std Pkg
8/80

16A Universal Socket

210100300314



Std Pkg
8/80

16A Universal Socket With USB

210100300317

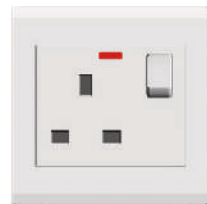

Std Pkg
8/80

13A Socket Neon

210800600005

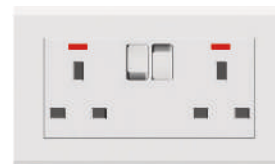

Std Pkg
5/50

13A 2 Gang Socket Neon

210800600006



Std Pkg
5/50

Cooker Unit

210800400003



BASIC WHITE

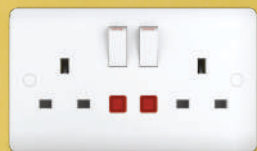

Std Pkg
10/100

10A 1 Gang 1 Way

210800100002

10A 1 Gang 2 Way

210800100003



Std Pkg
10/100

10A 2 Gang 1 Way

210800100004

10A 2 Gang 2 Way

210800100005



Std Pkg
10/100

10A 3 Gang 1 Way

210800100006

10A 3 Gang 2 Way

210800100007



Std Pkg
10/100

10A 4 Gang 1 Way (3X3)

210800600019

10A 4 Gang 2 Way (3X3)

210800600020



Std Pkg
10/100

10 A Bell Switch

210800200002



Std Pkg
10/100

15A Switched Socket

210800600004



Std Pkg
5/50

500W Fan Controller

210800700002



Std Pkg
5/50

500W Dimmer

210801000002

1000W Dimmer

210801000003



Std Pkg
10/100

20A DP With Neon

210800300002



Std Pkg
10/100

45A DP With Neon

210800300003



Std Pkg
10/100

3A Fuse Unit

210800100039



Std Pkg
10/100
5/50

20A Flex Outlet

210801300002

45A Flex Outlet

210801300003



Std Pkg
10/100

1 Gang Tel Socket RJ11

210801200002



Std Pkg
20

Shaver Socket

210100300271

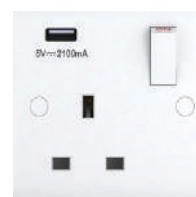

Std Pkg
10/100

13A 1G USB Switch Socket

210800600021



Std Pkg
5/50

13A 2G USB Switch Socket

210800600022

BASIC WHITE



Std Pkg
10/100

Satellite Socket

210800900002



Std Pkg
10/100

TV Socket

210800800002



Std Pkg
10/100

13A Switch Socket Neon

210800600002

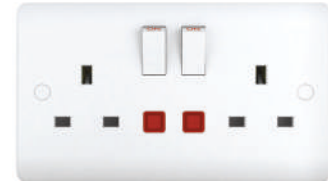

Std Pkg
5/50

13A 2G Switch Socket Neon

210800600003



Std Pkg
10/100

Rj45 Cat 5

210801100002



Std Pkg
10/100

Dual Rj45 Cat 5

210100300291



Std Pkg
10/100

13A Switch Socket

210800600017

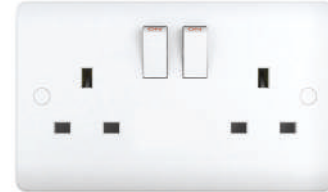

Std Pkg
5/50

13A 2G Switch Socket

210800600018



Std Pkg
5/50

45A Cooker Unit

210800400002



Std Pkg
5/50

10A 4 Gang 1 Way

210800100008

10A 4 Gang 2 Way

210800100009



Std Pkg
10/100

Single Blank Plate

210800500002



Std Pkg
10/100

Double Blank Plate

210800500003

CEILING ROSE/WATER PROOF



Std Pkg
10/100

Ceiling Rose

210100500097



Std Pkg
100

10A 1 Gang 2 Way

210800100034



Std Pkg
100

10A 2 Gang 2 Way

210800100035



Std Pkg
50

10A 3 Gang 2 Way

210800100036



Std Pkg
100

Bell Switch

210800200006



Std Pkg
100

20A DP Switch

210800300010



Std Pkg
50

1.5A Switched Socket

210800600016



Std Pkg
50

1.3A 1 Gang Switch Socket

210800600014



Std Pkg
25

1.3A 2 Gang Switch Socket

210800600015

DOOR BELL



Description:

Door bells are the fundamental requirement for any home or villa. Milano door bells are designed smartly & skilfully to suit any kind of homes/villas. These bells have long lasting finish with high quality sound output.

DOOR BELL

• Product Features:

1. AC 220-240V
2. Elegant Design.
3. 80DB of Sound Volume.
4. Compact Size
5. High Quality Sound.
6. Mechanical Ding-Dong Door Chime.

• Application:

Residential use.

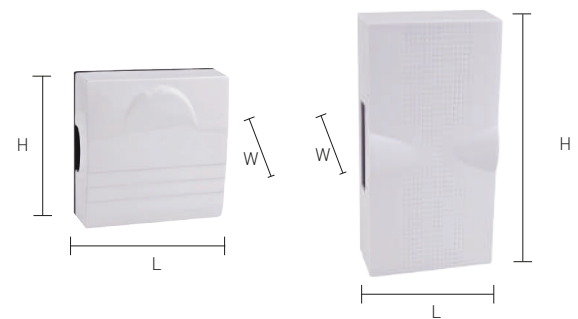



Barcode	Voltage	Description	Product Size(mm)	Std Pkg
210100300282	230V	Door Bell VIVO	L:105 H:170 W:49	40
210100300284	230V	Door Bell DIVA	L:116 H:116 W:48	40

CEILING FAN



Orchid



Vianny



Description:

Milano ceiling fans provides a strong airflow & also aids the circulation of cool air conditioning system, These fan help to maintain a constant temperature in the room to prevent the AC (or heater) from over working there-by saving energy.

ORCHID & VIEANNY CEILING FAN

• Product Features:

1. High speed fan.
2. Superior air delivery.
3. Excellent and long lasting paint finish.
4. Aesthetic silver ring on motor body of Vianny.
5. Safety cable is provided for motor.

• Application:

Commercial, Residential, Hospitals, Offices, Hotels, Retail Stores etc.



Sweep 56"

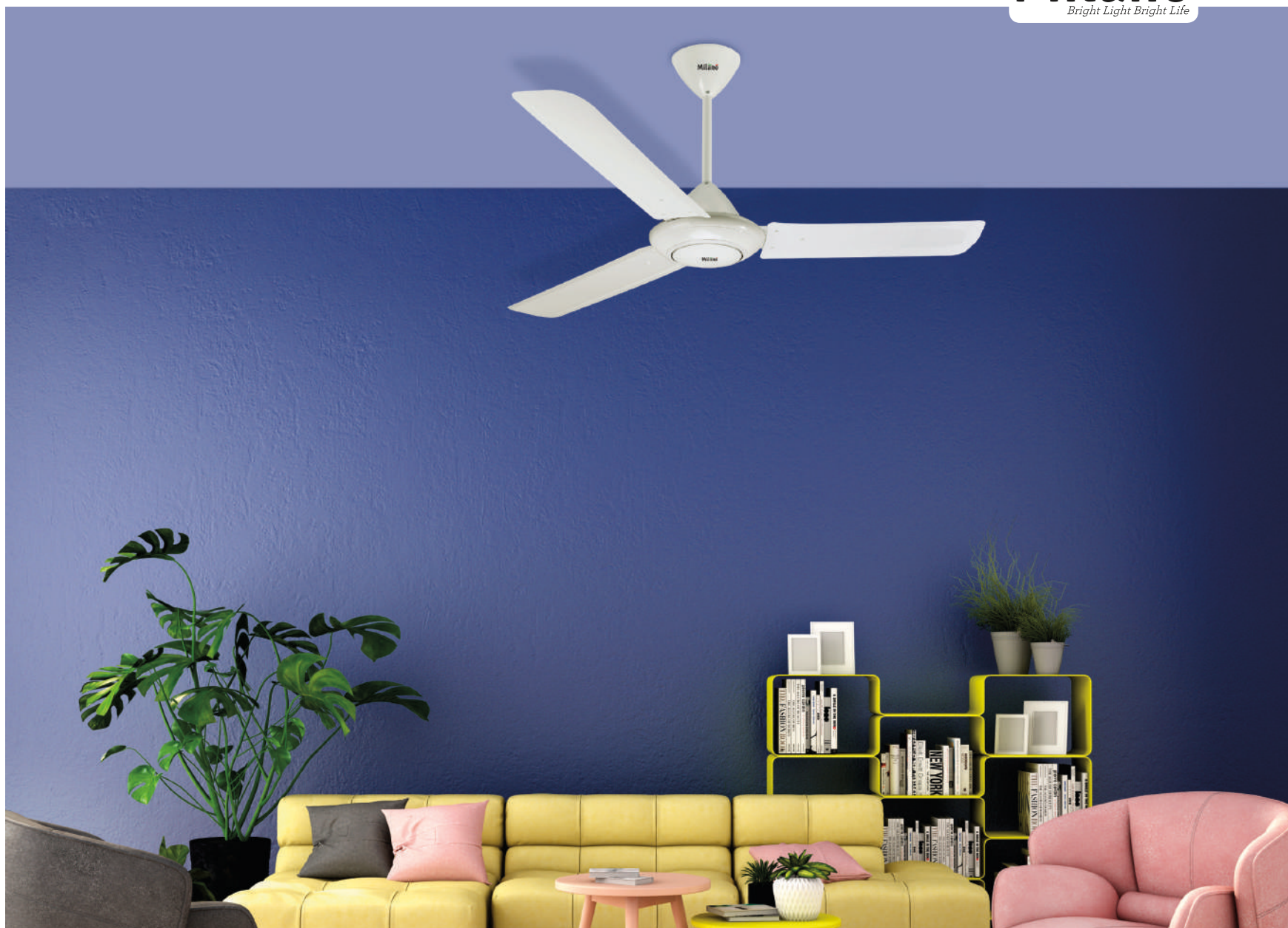

Barcode	Model	Power	Size	Voltage	Motor Weight	Air Delivery	RPM	Std pkg
210200100055	Orchid	80W	56"	220V-240V	3.5Kg	230m ³ /min	280	3
210200100063	Vianny Gold	75W	56"	220V-240V	3Kg	250m ³ /min	280	3
210200100064	Vianny Silver	75W	56"	220V-240V	3Kg	250m ³ /min	280	3

SQUARE/VELATINO AUTO SHUTTER EXHAUST FANS



Auto Shutter



Valentino



Description:

Milano auto shutter fan's are used to exhaust air through a wall, They are equipped with an outside shutter, which will smoothly open when the fan is on & vice versa. The strong blades deliver a smooth, turbulence free air flow resulting in high output and less noise level.

AUTO SHUTTER EXHAUST FAN

• Product Features:

1. LG ABS plastic body and shutters.
2. Elegant design and lower noise.
3. 100% pure copper winding.
4. Built in thermo-cut-off, protection for the motor.
5. Copper bush bearing motor.
6. Silicon steel lamination.

• Application:

Bathroom, Kitchen & Office pantry.





Barcode	Model	Power	Product Size(mm)	Voltage	Air Delivery	Noise	Std pkg
210700100007	Auto Shutter 6"	25W	L:205 H:205 W:125	220V-240V	298m ³ /min	35DB	10
210700900001	Valentino 6"	25W	L:222 H:230 W:163	220V-240V	230m ³ /min	43 DB	8
210700900002	Valentino 8"	32W	L:290 H:305 W:172	220V-240V	450m ³ /min	43 DB	8

EXHAUST FAN ROUND/SQUARE



Description:

Milano exhaust fan helps to force out stale air & pull fresh clean air through your facility for a more comfortable working environment. Common location for the exhaust fan include bathroom, kitchen these fans are usually very easy to install and can be used an array of locations.

EXHAUST FAN ROUND/SQUARE

• Product Features:

1. Top grade PP Plastic.
2. Elegant design & lower noise level.
3. Silicon steel motor & 100% pure copper winding.
4. Equip oil function, easy to remove & clean.
5. Lubricated using an imported solid lubricant.

• Application:

Bathrooms, Kitchens, Office pantry.



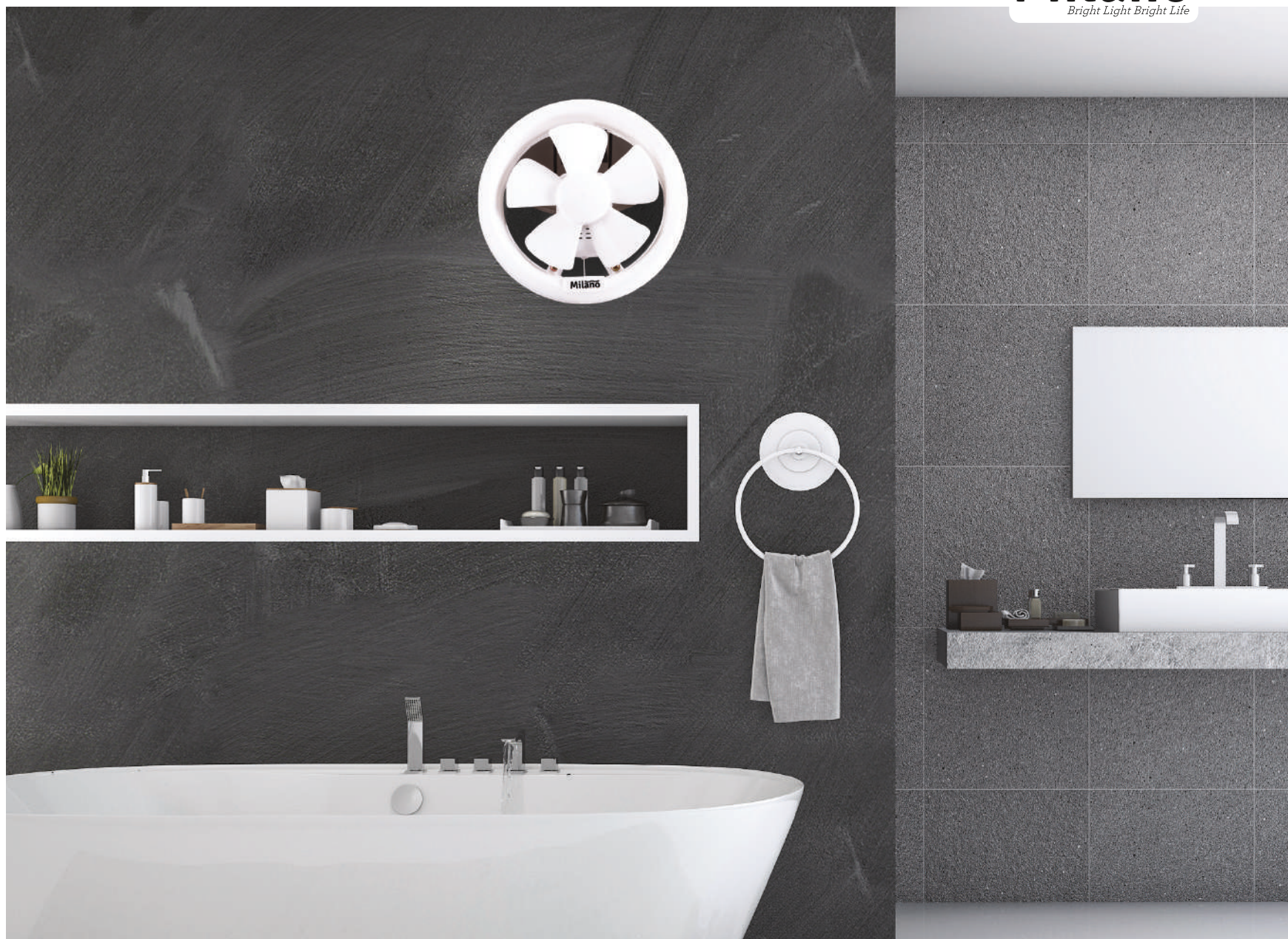

Barcode	Model	Power	Product Size(mm)	Voltage	Air Delivery	Noise	Std pkg
210700100001	6" Exhaust Fan RD	15W	L:210 H:210 W:97	220V-240V	3m3/min	36DB	8
210700100002	8" Exhaust Fan RD	26W	L:271 H:271 W:98	220V-240V	7m3/min	45DB	8
210700100006	6" Exhaust Fan SQ	25W	L:222 H:225 W:118	220V-240V	5m3/min	40DB	5
210700100003	8" Exhaust Fan SQ	30W	L:292 H:295 W:125	220V-240V	7m3/min	45DB	5
210700100004	10" Exhaust Fan SQ	43W	L:340 H:345 W:134	220V-240V	11m3/min	48DB	5

MIST FAN



Description:

Have you ever been to an outdoor party or a barbecue where the hosts set up a misting fan?

Yes, On a hot day there mist fan provides you temporary relief, they will cool the immediate area & make you feel refreshed with the water droplets that comes on you evaporate. These fans use high pressure to push water through small spray nozzles.

MIST FAN

• Product Features:

1. Beat the heat and be cool. It is easy to clean , Filter removes harmful tiny substances ,such as dust and pollen.
2. Energy saving,high-efficiency ,friendly environment the input power is 260w.
3. Wide rang of air output, 90 angle wide range of air output. 3 fan speeds: high-mid-low
4. Mist fan can be used virtually everywhere. Starting from industrial, domestic and commercial uses. Within industrial and commercial uses these fans have been found useful virtually in all types of environment. Some of its main users are listed below:

• Application:

- Household
- Restaurant and bars
- Public areas e.g. parks, airports, train stations etc
- Cattle, horse and poultry farms
- Manufacturing environment
- Hotels poolside and outdoor sitting areas
- Sports stadiums
- Green Houses





Barcode	Model	Power	Product Size	Voltage	Air Delivery	Noise	Std pkg
230401412904	Spider Mist Fan	300W	D:650mm H:1.75	220V-240V	5000-7500m ³ /hr	53-69DB	3

AIR COOLER

Delta



Aura



Mira



Kenda



Tulia



Description:

Danube Home Air cooler circulates the water to blow cool air. It lowers the surrounded temp & provides you a comfortable environment in hot summer. It humidifies the air to avoid skin dry & spal in winter. It absorbs negative ions to freshen the air & take care your health.

AIR COOLER

• Product Features:

1. Cool: It cycles the water to blow cool air. It can lower the surrounding temperature and provide you a comfortable environment in hot summer.
2. Humidifier : It humidifies the air to avoid skin dry and spall in winter.
3. Ionizer
It releases negative ions to freshen the air and care health.
4. Drawer style water tank, detachable filtration mesh
It is easy to clean. Filter removes harmful tiny substances, such as dust and pollen.
5. Energy saving, high-efficiency, friendly environment
The input power is 80- 200W.
6. Wide range of air output
100 angle wide range of air output. 3 fan speeds: HIGH-MID-LOW
7. Remote Control: 6 meters remote control, 120 angle wide range receiver.
8. Beep sound reminder: It has beep sound reminder function, convenient to use.
9. Memory Function: It can memorize the current working status. The memory is not cleaned until the power supply is off.
10. High grade computer control system.
11. 24 hours timer settings





Barcode	Model	Color	Power	Product Size	Voltage	Air Delivery	Weight	Std pkg
230401412906	Delta Air Cooler	Black& White	80W	L:280 H:280 W:650	220V-240V	600cm ³ /hr	5.7kg	1
230401412907	Aura Air Cooler	Black& White	100W	L:330 H:348 W:853	220V-240V	1000cm ³ /hr	7.4kg	1
230401412908	Mira Air Cooler	Black& White	100W	L:360 H:300 W:870	220V-240V	1500cm ³ /hr	9.5kg	1
230401412909	Kenda Air Cooler	Black& White	170W	L:375 H:345 W:1000	220V-240V	1600cm ³ /hr	11kg	1
230401412910	Tulia Air Cooler	Black& White	180W	L:378 H:442 W:1240	220V-240V	2000cm ³ /hr	12kg	1

AIR COOLER



Tulia Jumbo



Symphony

Description:

Danube Home Air cooler circulates the water to blow cool air. It lowers the surrounded temp & provides you a comfortable environment in hot summer. It humidifies the air to avoid skin dry & spal in winter. It absorbs negative ions to freshen the air & take care of your health.

AIR COOLER

• Product Features:

1. Cool: It cycles the water to blow cool air. It can lower the surrounding temperature and provide you a comfortable environment in hot summer.
2. Humidifier : It humidifies the air to avoid skin dry and spall in winter.
3. Ionizer
It releases negative ions to freshen the air and care health.
4. Energy saving, high-efficiency, friendly environment
The input power is 200W.
5. Remote Control: 8 meters remote control, 120° angle wide range receiver.
6. Beep sound reminder: It has beep sound reminder function, convenient to use.
7. 24 hours timer settings





Barcode	Model	Color	Power	Product Size	Voltage	Air Delivery	Weight	Std pkg
230401413233	Tulia Jumbo	White & Gold	200	416x515x1700mm	220-240V,50/60HZ	3500cbm/hour	16 kg	1
230401413234	Symphony	Black & White	200	679x440x1294mm	220-240V,50/60HZ	8000cbm/hour	20.5 kg	1

AIR COOLER



Description:

Danube Home air cooler circulates the water to blow cool air. It lowers the surrounded temp & provides you a comfortable environment in hot summer. It humidifies the air to avoid skin dry & spal in winter. It absorbs negative ions to freshen the air & take care your health.

AIR COOLER

• Product Features:

1. Cool soon: It circulates the water to blow cool air. It can lower the surrounding temperature and provides you a comfortable environment in hot summer.
2. Humidifier : It humidifies the air to avoid dryness of the skin and spal in winter.
3. Ionizer: absorbs negative ions to freshen the air and care health.
4. Built-in-water tank & detachable filtration mesh, help in easy cleaning. Filter removes harmful tiny substances, such as dust and pollen.
5. Energy saving, high-efficiency & friendly environment, the input power is 380W.
6. Wide range of air output, 6 meters remote control, 120 angle wide range receiver.
7. Beep sound reminder: It has beep sound reminder function, which is convenient to use.
8. Memory function: It can memorize the current working status. The memory is not cleaned until the power supply is off.
9. High grade computer control system.
10. 0.5 to 7.5 hours timer setting

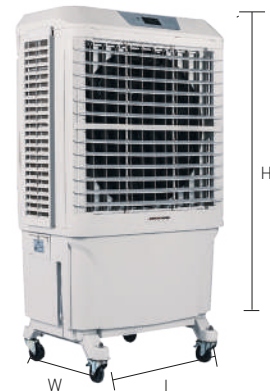



Barcode	Model	Power	Voltage	Airflow	Noise	Weight	Product Size	Std pkg
230401412591	Anton Air Cooler	380W	220-240V	8000m ³ /hr	57DB	35Kg	L:800 H:480 W:1380	1

VIDEO DOOR PHONES



7" Video Door Phone Silver



7" Video Door Phone With Photo Taking Function



7" Video Door Phone 2 Monitor With 1 Cam



Description:

Milano video door phone has 3 range (Single Monitor, 2 monitors with single camera & Auto photo taking function) & These VDP features 7 inch HD screen for clearer display. has the features of intercom system for Villa, home or office offering several operating modes.

VIDEO DOOR PHONE

• Product Features:

7" Video Door Phone Silver

1. Video intercom calling monitor.
2. Door release function.
3. Weather proof and durable.
4. Outdoor station with night vision.
5. Volume , Brightness, Melody adjust function.
6. Rain Protect cover for out door camera.

7" Video Door Phone With Photo Taking Function

1. Video intercom calling monitor.
2. Auto photo taking function, when the visitor press the outdoor button, 2 photos will taken & recorded automatically.
3. Door release function.
4. Weather proof and durable,rain protect cover for out door camera.
5. Outdoor station with night vision.
6. Volume , Brightness, Melody adjust function.

7" Video Door Phone 2 Monitor With 1 Cam

1. Outdoor units with 2 calling button, Can be used to call Villa with 2 floors or Flats
2. Two HD indoor Monitor , can be used in 2 different rooms of same villa or flats
3. Weather proof and durable,Rain Protect cover for out door camera.
4. Volume , Brightness, Melody adjust function
5. Outdoor station with night vision.

• Application:

Villa, Flats, Residential apartments etc..



Barcode	Model	Size	Std pkg
210900100001	Video Door Phone Silver	7" Screen	5
210900100003	Video Door Phone With Photo Taking Function	7" Screen	5
210900100004	Video Door Phone with 2 Monitor & 1 Cam	7" Screen	2

INTERCOM & CALLING BELL



2 Way Wireless Intercom



4 Way Wireless Intercom



Wireless Doorbell LED Light
with Batteries



Wireless Doorbell With Batteries



Description:

Milano intercom systems are an excellent way to communicate with your family members/ other members in your home or office, unlike traditional intercom systems, wireless systems are easy to install and usually don't require any additional wiring system they are simple to remove if in-case you decide to move one place to other.

INTERCOM & CALLING BELL

• Product Features:

2/4 Way Wireless Intercom

1. Duplex intercommunication with two way wireless intercom.
2. Four Way intercommunication, Each hand set can be used to communicate to 3 other different hand set.
3. Communication within 50 mtrs of Same Building.
4. Clear & Wire less digital transmission of intercommunication signals.
5. Enclosed Adaptor for DIY

Calling Bell

1. 3A Batteries can work about 1-2 years.
2. The remote controlling distance is about 150mtrs within the building.
3. Saves energy 5 times more than the old/traditional products.
4. 16 pleasant ringtones for option.

• Application:

Villa, Flats, Residential Apartments etc.



Barcode	Model	Std pkg
210900200001	2 Way Wireless Intercom	10
210900200002	4 Way Wireless Intercom	6
210900300003	Wireless Doorbell LED Light With Batteries	50
210900300004	Wireless Doorbell With Batteries	50

DISCONTINUED PRODUCTS

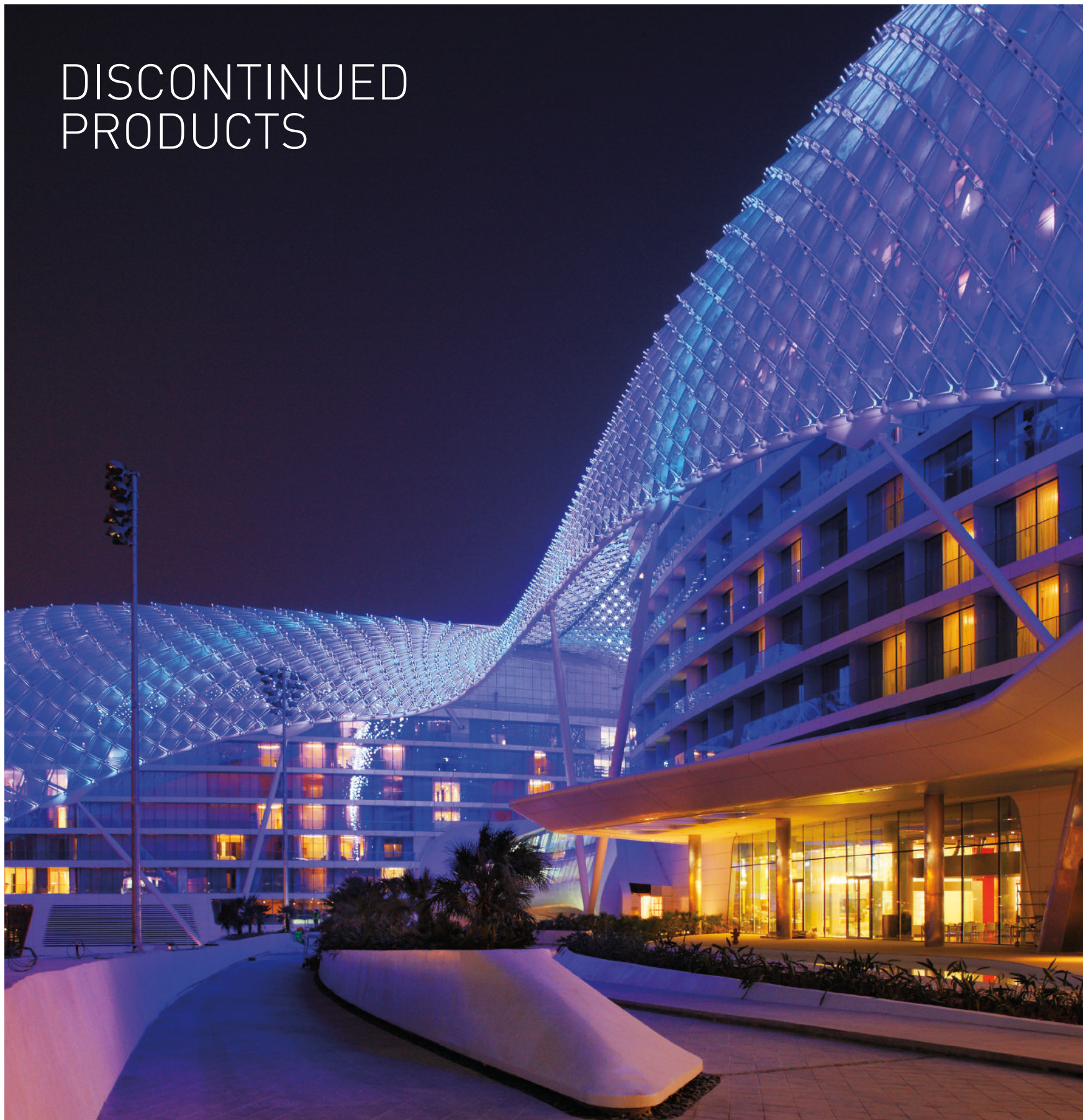

LED SPOT LIGHT

Milano
Bright Light Bright Life



Barcode	Description	Power	Color Temp	Voltage	Product Size(mm)	Lumen(lm)	Std pkg
210302400001	Spotlight-Fix	3W	6000k	220-240V	D:70 H:42 Cut:52	220	100
210302400002	Spotlight-Fix	3W	3000k	220-240V	D:70 H:42 Cut:52	220	100
210302400003	Spotlight-Fix	6W	6000k	220-240V	D:87 H:45 Cut:63	450	50
210302400004	Spotlight-Fix	6W	3000k	220-240V	D:87 H:45 Cut:63	450	50
210302400005	Spotlight-Fix	9W	6000k	220-240V	D:98 H:52 Cut:75	750	50
210302400006	Spotlight-Fix	9W	3000k	220-240V	D:98 H:52 Cut:75	750	50

COLOR FRAME LED SPOT LIGHTS

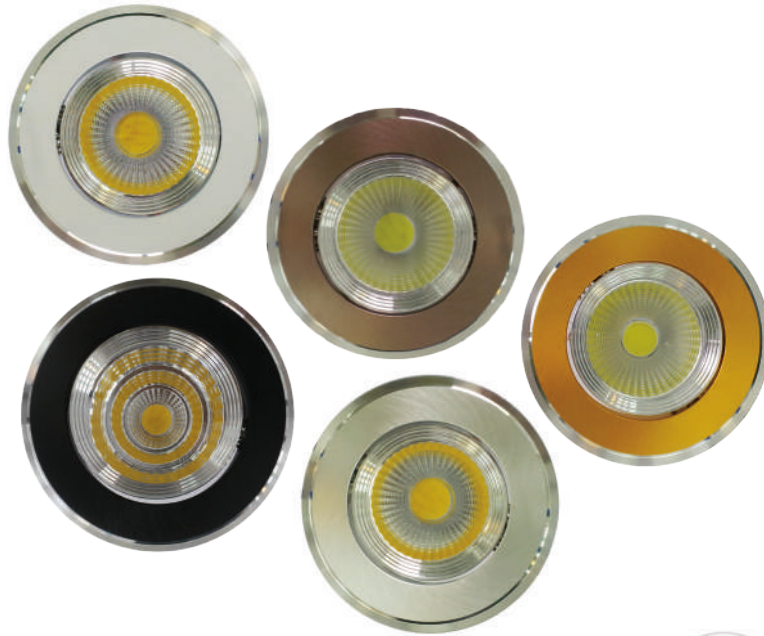

Description:

Milano color frame spot lights are the ideal to match for your interiors and are available in a wide range of color options to choose.

These are easy to install with highly efficient LED light source that saves about 90% of energy.



COLOR FRAMES LED SPOT LIGHTS

• Product Features:

1. Attractive appearance.
2. High quality Aluminium provides good heat dissipation for erosion resistance.
3. High quality LED chips, Provides ≥ 80 Lumen per watt, High CRI ≥ 80 , restores the color of the object.
4. Constant current designs, multi protection, no flickering & best in performance.

• Application:

Commercial, Residential, Hotels, Retail Stores, focusing objects etc.

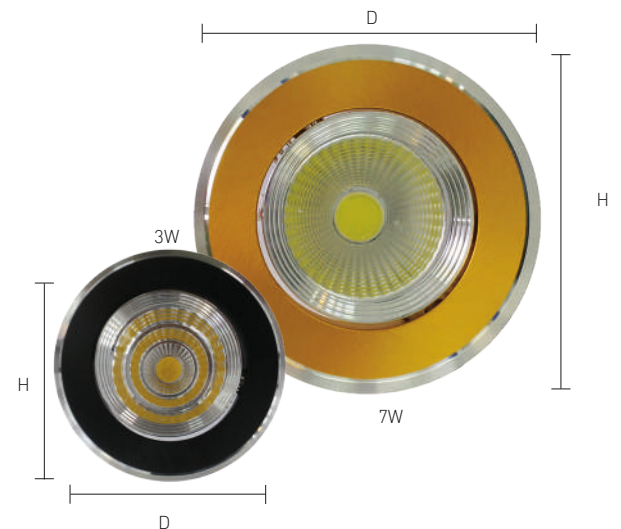



Barcode	Description	Voltage	Power	Color Temp	Lumen(lm)	Product Size(mm)	Std pkg
210301800005	White Frame	85-265V	3W	6000k	210	D:68 H:45 Cut:52	100
210301800006	White Frame	85-265V	3W	3000k	210	D:68 H:45 Cut:52	100
210301800017	Coffee Frame	85-265V	3W	6000k	210	D:68 H:45 Cut:52	100
210301800018	Coffee Frame	85-265V	3W	3000k	210	D:68 H:45 Cut:52	100
210301800001	Gold Frame	85-265V	3W	6000k	210	D:68 H:45 Cut:52	100
210301800002	Gold Frame	85-265V	3W	3000k	210	D:68 H:45 Cut:52	100
210301800009	Silver Frame	85-265V	3W	6000k	210	D:68 H:45 Cut:52	100
210301800010	Silver Frame	85-265V	3W	3000k	210	D:68 H:45 Cut:52	100
210301800013	Black Frame	85-265V	3W	6000k	210	D:68 H:45 Cut:52	100
210301800014	Black Frame	85-265V	3W	3000k	210	D:68 H:45 Cut:52	100
210301800007	White Frame	85-265V	7W	6000k	560	D:88 H:56 Cut:67	50
210301800008	White Frame	85-265V	7W	3000k	560	D:88 H:56 Cut:67	50
210301800019	Coffee Frame	85-265V	7W	6000k	560	D:88 H:56 Cut:67	50
210301800020	Coffee Frame	85-265V	7W	3000k	560	D:88 H:56 Cut:67	50
210301800003	Gold Frame	85-265V	7W	6000k	560	D:88 H:56 Cut:67	50
210301800004	Gold Frame	85-265V	7W	3000k	560	D:88 H:56 Cut:67	50
210301800011	Silver Frame	85-265V	7W	6000k	560	D:88 H:56 Cut:67	50
210301800012	Silver Frame	85-265V	7W	3000k	560	D:88 H:56 Cut:67	50
210301800015	Black Frame	85-265V	7W	6000k	560	D:88 H:56 Cut:67	50
210301800016	Black Frame	85-265V	7W	3000k	560	D:88 H:56 Cut:67	50

SPOT LIGHT FRAMES

	<table border="1"> <thead> <tr> <th>Barcode</th> <th>Description</th> <th>Power</th> <th>Color</th> <th>Std Pkg</th> </tr> </thead> <tbody> <tr> <td>210400200006</td> <td>GD Milky Glass</td> <td>N/A</td> <td>N/A</td> <td>30</td> </tr> </tbody> </table>	Barcode	Description	Power	Color	Std Pkg	210400200006	GD Milky Glass	N/A	N/A	30
Barcode	Description	Power	Color	Std Pkg							
210400200006	GD Milky Glass	N/A	N/A	30							
	<table border="1"> <thead> <tr> <th>Barcode</th> <th>Description</th> <th>Power</th> <th>Color</th> <th>Std Pkg</th> </tr> </thead> <tbody> <tr> <td>210400200003</td> <td>SL Flower Crystal</td> <td>N/A</td> <td>N/A</td> <td>30</td> </tr> </tbody> </table>	Barcode	Description	Power	Color	Std Pkg	210400200003	SL Flower Crystal	N/A	N/A	30
Barcode	Description	Power	Color	Std Pkg							
210400200003	SL Flower Crystal	N/A	N/A	30							
	<table border="1"> <thead> <tr> <th>Barcode</th> <th>Description</th> <th>Power</th> <th>Color</th> <th>Std Pkg</th> </tr> </thead> <tbody> <tr> <td>210400200004</td> <td>GD Flower Crystal</td> <td>N/A</td> <td>N/A</td> <td>30</td> </tr> </tbody> </table>	Barcode	Description	Power	Color	Std Pkg	210400200004	GD Flower Crystal	N/A	N/A	30
Barcode	Description	Power	Color	Std Pkg							
210400200004	GD Flower Crystal	N/A	N/A	30							
	<table border="1"> <thead> <tr> <th>Barcode</th> <th>Description</th> <th>Power</th> <th>Color</th> <th>Std Pkg</th> </tr> </thead> <tbody> <tr> <td>210400200011</td> <td>SL Lining Plate</td> <td>N/A</td> <td>N/A</td> <td>30</td> </tr> </tbody> </table>	Barcode	Description	Power	Color	Std Pkg	210400200011	SL Lining Plate	N/A	N/A	30
Barcode	Description	Power	Color	Std Pkg							
210400200011	SL Lining Plate	N/A	N/A	30							
	<table border="1"> <thead> <tr> <th>Barcode</th> <th>Description</th> <th>Power</th> <th>Color</th> <th>Std Pkg</th> </tr> </thead> <tbody> <tr> <td>210400200010</td> <td>GD Lining Plate</td> <td>N/A</td> <td>N/A</td> <td>30</td> </tr> </tbody> </table>	Barcode	Description	Power	Color	Std Pkg	210400200010	GD Lining Plate	N/A	N/A	30
Barcode	Description	Power	Color	Std Pkg							
210400200010	GD Lining Plate	N/A	N/A	30							
	<table border="1"> <thead> <tr> <th>Barcode</th> <th>Description</th> <th>Power</th> <th>Color</th> <th>Std Pkg</th> </tr> </thead> <tbody> <tr> <td>210400200007</td> <td>SQ Silver Plate</td> <td>N/A</td> <td>N/A</td> <td>30</td> </tr> </tbody> </table>	Barcode	Description	Power	Color	Std Pkg	210400200007	SQ Silver Plate	N/A	N/A	30
Barcode	Description	Power	Color	Std Pkg							
210400200007	SQ Silver Plate	N/A	N/A	30							



Barcode	Description	Power	Color	Std Pkg
210400200008	SQ Gold Plate	N/A	N/A	30



Barcode	Description	Power	Color	Std Pkg
210400200009	SQ Bronze Plate	N/A	N/A	30



Barcode	Description	Power	Color	Std Pkg
210400200005	CH Milky Glass	N/A	N/A	30



Barcode	Description	Power	Color	Std Pkg
210400200012	SL Crystal Plate	N/A	N/A	30



Barcode	Description	Power	Color	Std Pkg
210400200001	GD Crystal Plate	N/A	N/A	30



Barcode	Description	Power	Color	Std Pkg
210400200002	Diamond Crystal Plate	N/A	N/A	30

LED DOWN LIGHT



Description:

Milano LED down light commercial range are the perfect replacement for conventional down light with CFL's, with an attractive appearance and uniform light distribution.

These lights are widely used for office, conference room, department stores and shop, etc.



LED DOWN LIGHT

• Product Features:

1. Attractive appearance, high quality pure Aluminium housing, good heat dissipation and erosion resistant.
2. High CRI >80, which restores true color of object.
3. Adopts constant current supply to start up the light quickly.
4. Mercury free Eco friendly and high energy saving.
5. Easy installation & zero maintenance.

• Application:

Commercial, Residential, Hospital, Restaurant, Shopping mall etc.

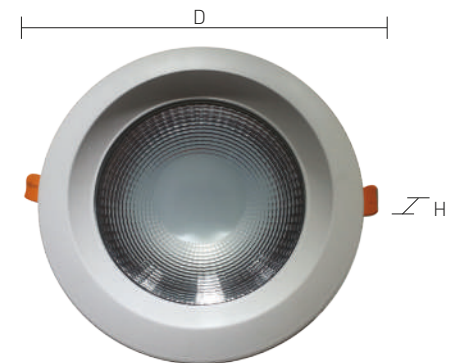



Barcode	Product Size(mm)	Voltage	Lifespan	Power	Color Temp	Lumen(lm)	Std pkg
210300300001	D:110 H:50 Cut:95	220-240V	25,000 Hrs	10W	6500k	≥700	40
210300300002	D:110 H:50 Cut:95	220-240V	25,000 Hrs	10W	3000k	≥700	40
210300300003	D:168 H:60 Cut:145	220-240V	25,000 Hrs	20W	6500k	≥1400	20
210300300004	D:168 H:60 Cut:145	220-240V	25,000 Hrs	20W	3000k	≥1400	20
210300300005	D:195 H:60 Cut:165	220-240V	25,000 Hrs	30W	6500k	≥2100	20
210300300006	D:195 H:60 Cut:165	220-240V	25,000 Hrs	30W	3000k	≥2100	20

EXTENSION SOCKET



Barcode	Description	Std Pkg
211000500001	3 Mtr 5 Socket	24
211000500002	5 Mtr 5 Socket	24



Barcode	Description	Std Pkg
211000400001	5Mtr 4 Socket With USB	24



Barcode	Description	Std Pkg
211000300002	3 Mtr 3 Socket	24
211000300003	5 Mtr 3 Socket	24



Barcode	Description	Std Pkg
211000500003	5 Mtr 5 Socket Twist	24



Barcode	Description	Std Pkg
211000300001	3 Socket Fixed	36



Barcode	Description	Std Pkg
211000400002	4 Socket Cable Reel- 25 Mtr	4
211000400003	4 Socket Cable Reel- 50 Mtr	4



Barcode	Description	Code Length	Voltage	Std Pkg
211000500006	5 Socket	5mtr	250V	20



Barcode	Description	Code Length	Voltage	Std Pkg
211000400004	4 Socket	5mtr	250V	20



Barcode	Description	Code Length	Voltage	Std Pkg
211000800001	3 Socket (T-type)	N/A	250V	20



Barcode	Description	Power	Power Supply	Std Pkg
210100800007	Multicolor LED Toilet Light	0.5W	3xAAA battery	100

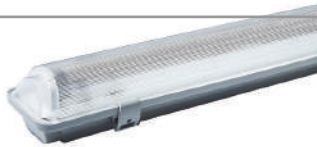

Barcode	Description	Power	Color	Std Pkg
210600100001	1x18W Water Proof Fitting	N/A	N/A	10
210600100002	1x36W Water Proof Fitting	N/A	N/A	10



Barcode	Description	Power	Color	Std Pkg
210600100003	2x18W Water Proof Fitting	N/A	N/A	10
210600100004	2x36W Water Proof Fitting	N/A	N/A	8



Barcode	Description	Power	Color	Std Pkg
210303500002	Led T8 Tube	16W	6000K	25
210303500001	Led T8 Tube	9W	6000K	25



Barcode	Description	Power	Color	Std Pkg
210304200003	LED Mirror Light Canopy	14W	6500K	6



Barcode	Description	Size(mm)	Power	Color	Std Pkg
210305400001	Cabinet Light	L:300 W:30 H:70	1.6W	6500K	36



Barcode	Description	Std Pkg
210700100005	12" Exhaust Fan	5

LED CEILING LIGHTS WALL BRACKET



Barcode	Description	Power	Size	Std Pkg
210301400008	SQ Ceiling Gold Border Light (L)	48W	650mm	1



Barcode	Description	Power	Size	Std Pkg
210301400001	Decorative Plain Ceiling Light	20W	350mm	10



Barcode	Description	Power	Size	Std Pkg
210301400002	Plain Round Ceiling Light	20W	350mm	10



Barcode	Description	Power	Size	Std Pkg
210301400003	BL Flower Ceiling Light	20W	350mm	10



Barcode	Description	Power	Color	Std Pkg
210100200176	LED Wall bracket Half Oval IP-65	7 W	6500k	12
210100200177	LED Wall bracket Half Oval IP-65	7 W	3000k	12



Barcode	Description	Power	Size	Std Pkg
210301400004	VL Flower Ceiling Light	20W	350mm	10



Barcode	Description	Power	Size	Std Pkg
210301400005	Double Ring Ceiling Light (S)	24W	350mm	10



Barcode	Description	Power	Size	Std Pkg
210301400006	Double Ring Ceiling Light (L)	32W	450mm	1



Barcode	Description	Power	Size	Std Pkg
210301400007	SQ Ceiling Gold Border Light (L)	24W	450mm	1



Barcode	Description	Power	Color	Std Pkg
210100200172	LED Wall bracket with Half grill IP-54	8W	6500K	20
210100200173	LED Wall bracket with Half grill IP-54	8W	3000K	20

CFL U/SPIRAL TYPE SERIES



Description:

Milano CFL Spiral and U-type guaranteed on your electricity bills at home & office. They have a longer life than standard traditional filament bulbs, and can be easily replaced.

These CFL bulbs fits in most lighting fixtures & energy saving is about 80 to 90% less over the incandescent bulb.



CFL U/ SPIRAL TYPE

• Product Features:

1. Compact design
2. Beautiful pinhole cooling design.
3. Good heat dissipation and avoids the insects climbing inside the lamp shell.
4. High level of energy efficiency and higher brightness.
5. Quick start, smaller size higher lumen output.
6. 80% energy saving.

• Application:

Commercial, residential, hotels, hospitals, retail stores, etc.





Barcode	Model	Power	Color Temp	Voltage	Product Size(mm)	Cap Base	Lumen(lm)	Std pkg
210500100001	3U T3	11W	6500K	220-240V	L:124 D:40	E14	690	100
210500100002	3U T3	11W	2700K	220-240V	L:124 D:40	E14	690	100
210500100003	3U T3	15W	6500K	220-240V	L:144 D:40	E14	840	100
210500100004	3U T3	15W	2700K	220-240V	L:144 D:40	E14	840	100
210500100005	3U T3	11W	6500K	220-240V	L:124 D:40	E27	690	100
210500100006	3U T3	11W	2700K	220-240V	L:124 D:40	E27	690	100
210500100007	3U T3	15W	6500K	220-240V	L:144 D:40	E27	840	100
210500100008	3U T3	15W	2700K	220-240V	L:144 D:40	E27	840	100
210500100009	3U T4	20W	6500K	220-240V	L:168 D:48	E27	1080	50
210500100010	3U T4	20W	2700K	220-240V	L:168 D:48	E27	1080	50
210500100011	3U T4	26W	6500K	220-240V	L:178 D:48	E27	1450	50
210500100012	3U T4	26W	2700K	220-240V	L:178 D:48	E27	1450	50
210500100013	4U T4	30W	6500K	220-240V	L:172 D:59	E27	1600	50
210500200001	Spiral	11W	6500K	220-240V	L:98 D:39	E14	690	100
210500200002	Spiral	11W	2700K	220-240V	L:98 D:39	E14	690	100
210500200003	Spiral	15W	6500K	220-240V	L:108 D:45	E14	840	100
210500200004	Spiral	15W	2700K	220-240V	L:108 D:45	E14	840	100
210500200005	Spiral	11W	6500K	220-240V	L:98 D:39	E27	690	100
210500200006	Spiral	11W	2700K	220-240V	L:98 D:39	E27	690	100
210500200007	Spiral	15W	2700K	220-240V	L:108 D:45	E27	840	100
210500200008	Spiral	15W	6500K	220-240V	L:108 D:45	E27	840	100
210500200009	Spiral	20W	6500K	220-240V	L:114 D:45	E27	1080	100
210500200010	Spiral	20W	2700K	220-240V	L:114 D:45	E27	1080	100
210500200011	Spiral	26W	6500K	220-240V	L:122 D:52	E27	1450	100
210500200012	Spiral	26W	2700K	220-240V	L:122 D:52	E27	1450	100
210500200013	Spiral	30W	6500K	220-240V	L:137 D:65	E27	1600	50
210500200014	Spiral	30W	2700K	220-240V	L:137 D:65	E27	1600	50

LED FLOOD LIGHT

Power: 10W, 20W, 30W, 50W



SMD SERIES

Power: 15W, 30W, 60W, 100W, 150W, 300W



Power: 100W



Power: 150W



Description:

Milano flood light, comes with a high intensity die-cast Aluminium body. Better heat distribution structure material. It can resist the impact and friction. The Lumen efficiency can reach up to 90%. LED flood light are widely used in shopping center, parking lot and either indoor and outdoor light application.



RECHARGEABLE FLOOD LIGHT

• Product Features:

1. Attractive appearance, high quality pure Aluminium housing, good heat dissipation and erosion resistant.
2. High CRI > 80, which restores true color of object. IP-65
3. Adopts constant current supply to start up the light quickly.

• Application:

Commercial, Residential, Hospital, Restaurant, Shopping mall etc.



Barcode	Description	Power	Color	Std Pkg
210300400001	LED Flood Light	10W	6000K	40
210300400002	LED Flood Light	10W	3000K	40
210300400003	LED Flood Light	20W	6000K	20
210300400004	LED Flood Light	20W	3000K	20
210300400005	LED Flood Light	30W	6000K	10
210300400006	LED Flood Light	30W	3000K	10
210300400007	LED Flood Light	30W	RGB	10
210300400008	LED Flood Light	50W	6000K	8
210300400009	LED Flood Light	50W	3000K	8
210300500001	LED Flood Light With Lens	100W	6000K	1
210300500002	LED Flood Light With Lens	100W	3000K	1
210300500003	LED Flood Light With Lens	150W	6000K	1
210300500004	LED Flood Light With Lens	150W	3000K	1
210300400014	SMD Series	15W	6500k	40
210300400015	SMD Series	15W	3000k	40
210300400016	SMD Series	30W	6500k	20
210300400017	SMD Series	30W	3000k	20
210300400018	SMD Series	60W	6500k	10
210300400019	SMD Series	60W	3000k	10
210300400021	SMD Series	100W	6500k	8
210300400020	SMD Series	100W	3000k	8
210300400022	SMD Series	150W	6500k	5
210300400023	SMD Series	150W	3000k	5
210300400024	SMD Series	300W	6500k	1

LED CANDLE LAMP

LED Gold & Silver tip candle lamp



LED Gold & Silver base candle lamp



LED Filament with & without tip candle lamp



LED Gold & Silver base candle lamp



Barcode	Description	Power	Cap Base	Product Size(mm)	Color Temp	Lumen(lm)	Std pkg
210304900008	LED Gold Tip Candle Lamp	2Pcs X 4W	E-14	L:135 D:40	6000k	320LM±5%	50
210304900006	LED Gold Tip Candle Lamp	2Pcs X 4W	E-14	L:135 D:40	3000k	320LM±5%	50
210304900009	LED Silver Tip Can dle Lamp	2Pcs X 4W	E-14	L:135 D:40	6000k	320LM±5%	50
210304900007	LED Silver Tip Candle Lamp	2Pcs X 4W	E-14	L:135 D:40	3000k	320LM±5%	50
210100800004	LED Gold Base Candle Lamp	3W	E-14	L:145 D:40	3000k	270LM±5%	100
210100800005	LED Silver Base Candle Lamp	3W	E-14	L:145 D:40	3000k	270LM±5%	100
210303300001	LED Filament Candle Lamp With Tip	2W	E-14	L:95 D:35	6000K	180LM±5%	100
210303300002	LED Filament Candle Lamp With Tip	2W	E-14	L:95 D:35	2700K	180LM±5%	100
210303400001	LED Filament Candle Lamp W/O Tip	2W	E-14	L:95 D:35	6000K	180LM±5%	100
210303400002	LED Filament Candle Lamp W/O Tip	2W	E-14	L:95 D:35	2700K	180LM±5%	100
210301100010	LED Capsule	1W	N/A		6000K		100
210301100009	LED Capsule	1W	N/A		3000K		100

CERTIFICATES



هيئة الإمارات للمواصفات والمقاييس
Emirates Authority For Standardization & Metrology

شهادة مطابقة CERTIFICATE OF CONFORMITY



Certificate Number: 18-02-2950/E18-02-003049 رقم الشهادة:
Issue Date: 28-February-2018 تاريخ الإصدار:
Valid Until: 27-February-2019 صلاحية لفترة:
Issued To: Danube Building Materials FZCO أصدرت إلى:
P.O. Box 18022, Dubai, United Arab Emirates

Product Category: General Use Mains Plugs, Socket-outlets تصنيف المنتج: المقابس والمقابس للاستخدام العام
Product Name: Switched Socket-outlet (Fixed type) اسم المنتج: مقفاح خارجي (نوع مثبت)
Product Details: See Schedule Of Certification تفاصيل المنتج: انظر بين التسجيل المرفق

Product is registered under the Emirates Conformity Assessment Scheme (ECAS) based on compliance to the following requirements: المنتج مسجل في نظام تقييم المطابقة الإماراتي (إيكاس) بناء على مطابقتها للمتطلبات التالية:
UAES IEC 60844-2-3, UAES IEC 60884-1 UAES IEC 60844-2-3, UAES IEC 60884-1



جهة معيّنة من قبل هيئة الإمارات للمواصفات والمقاييس
Notified Body by Emirates Authority for Standardization & Metrology



Visit ESMA website www.esma.gov.ae to verify this certification.
www.esma.gov.ae
Any changes or modification on this certificate will affect its validity.
SGS Gulf Limited (DAFZ Branch)
Office # 626, Building- 5WA, Al Quds Street, Dubai Airport Free Zone
Dubai - United Arab Emirates

+971 4 2983960
www.me.sgs.com
Me.Sgs.Emas@sgs.com

تأكد من صحة هذه الشهادة بزيارة موقع هيئة الإمارات للمواصفات والمقاييس على الإنترنت: www.esma.gov.ae
أي تغيير أو تعديل على هذه الشهادة ينعكس على صحتها.
اس جي سي ليميتد فرع المنطقة الحرة بسطرا (DAFZ فرع)
مكتب رقم 626، مبنى 5WA، شارع القدس، المنطقة الحرة في مطار دبي، الإمارات العربية المتحدة

Extension Socket



هيئة الإمارات للمواصفات والمقاييس
Emirates Authority For Standardization & Metrology

شهادة مطابقة CERTIFICATE OF CONFORMITY



Certificate Number: 18-02-2951/E18-02-003050 رقم الشهادة:
Issue Date: 28-February-2018 تاريخ الإصدار:
Valid Until: 27-February-2019 صلاحية لفترة:
Issued To: Danube Building Materials FZCO أصدرت إلى:
P.O. Box 18022, Dubai, United Arab Emirates

Product Category: Fan and Fan Systems تصنيف المنتج: المراوح ونظمة المراوح
Product Name: Ventilating Fan اسم المنتج: مروحة تهوية
Product Details: See Schedule Of Certification تفاصيل المنتج: انظر بين التسجيل المرفق

Product is registered under the Emirates Conformity Assessment Scheme (ECAS) based on compliance to the following requirements: المنتج مسجل في نظام تقييم المطابقة الإماراتي (إيكاس) بناء على مطابقتها للمتطلبات التالية:
UAES IEC 60335-2-80, UAES IEC 60335-1 UAES IEC 60335-2-80, UAES IEC 60335-1



جهة معيّنة من قبل هيئة الإمارات للمواصفات والمقاييس
Notified Body by Emirates Authority for Standardization & Metrology



Visit ESMA website www.esma.gov.ae to verify this certification.
www.esma.gov.ae
Any changes or modification on this certificate will affect its validity.
SGS Gulf Limited (DAFZ Branch)
Office # 626, Building- 5WA, Al Quds Street, Dubai Airport Free Zone
Dubai - United Arab Emirates

+971 4 2983960
www.me.sgs.com
Me.Sgs.Emas@sgs.com

تأكد من صحة هذه الشهادة بزيارة موقع هيئة الإمارات للمواصفات والمقاييس على الإنترنت: www.esma.gov.ae
أي تغيير أو تعديل على هذه الشهادة ينعكس على صحتها.
اس جي سي ليميتد فرع المنطقة الحرة بسطرا (DAFZ فرع)
مكتب رقم 626، مبنى 5WA، شارع القدس، المنطقة الحرة في مطار دبي، الإمارات العربية المتحدة

Exhaust Fans

CERTIFICATES



هيئة الإمارات للمواصفات والمقاييس
Emirates Authority For Standardization & Metrology



شهادة مطابقة CERTIFICATE OF CONFORMITY

Certificate Number: 18-02-2961/E18-02-003054 رقم الشهادة:
Issue Date: 28-February-2018 تاريخ الاصدار:
Valid Until: 27-February-2019 صالحة لغاية:
Issued To: Danube Building Materials FZCO أصدرت إلى:
P.O. Box 18022, Dubai, United Arab Emirates

Product Category: Switches & Dimmers تصنيف المنتج: مقايح التبديل ومقايح التحكم بشدة الإضاءة
Product Name: Flush-Type Rocker Double-Pole اسم المنتج: مقايح كهربيين تنامي القطب مع لعبة
Switches with Lamp
Product Details: See Schedule Of Certification تفاصيل المنتج: انظر بيان التسجيل المرفق

Product is registered under the Emirates Conformity Assessment Scheme (ECAS) based on compliance to the following requirements: المنتج مسجل في نظام تقويم المطابقة الإماراتي (إيكاس) بناء على مطابقته للمتطلبات التالية:
UAE.S IEC 60669-1 UAE.S IEC 60669-1

SGS
جهة معيّنة من قبل هيئة الإمارات للمواصفات والمقاييس
Notified Body by Emirates Authority for Standardization & Metrology



Visit ESMA website www.esma.gov.ae to verify this certification.
www.sgs.com
Any changes or modification on this certificate will affect its validity.
SGS Gulf Limited (DAFZ Branch)
Office # 625, Building 5/WA, Al Qudra Street, Dubai Airport Free Zone
Dubai - United Arab Emirates

+971 4 2283980
www.sgs.com
Me.Sgs.Emas@sgs.com

تأكد من صحة هذه الشهادة برعي زيارة موقع هيئة الإمارات للمواصفات والمقاييس على الإنترنت: www.esma.gov.ae
أي تغيير أو تعديل في هذه الشهادة يماحها
إن عني إن جلد إيميل الإزعج المنطقة الحرة دبي
مكتب رقم 625 - مبنى 5/WA شارع القدس المنطقة الحرة في مطار دبي - الإمارات العربية المتحدة

Extension Socket



هيئة الإمارات للمواصفات والمقاييس
Emirates Authority For Standardization & Metrology



شهادة مطابقة CERTIFICATE OF CONFORMITY

Certificate Number: 18-02-2953/E18-02-003052 رقم الشهادة:
Issue Date: 28-February-2018 تاريخ الاصدار:
Valid Until: 27-February-2019 صالحة لغاية:
Issued To: Danube Building Materials FZCO أصدرت إلى:
P.O. Box 18022, Dubai, United Arab Emirates

Product Category: General Use Mains Plugs, Socket- outlets تصنيف المنتج: المقابس والمقابس للاستخدام العام
Product Name: Single-Phase Flush-Type Two-Pole Switched Socket-Outlet with Earthing-Contact اسم المنتج: مقايح خارجي له الصل بالأرضي
Product Details: See Schedule Of Certification تفاصيل المنتج: انظر بيان التسجيل المرفق

Product is registered under the Emirates Conformity Assessment Scheme (ECAS) based on compliance to the following requirements: المنتج مسجل في نظام تقويم المطابقة الإماراتي (إيكاس) بناء على مطابقته للمتطلبات التالية:
UAE.S IEC 60884-2-3, UAE.S IEC 60884-1 UAE.S IEC 60884-2-3, UAE.S IEC 60884-1

SGS
جهة معيّنة من قبل هيئة الإمارات للمواصفات والمقاييس
Notified Body by Emirates Authority for Standardization & Metrology



Visit ESMA website www.esma.gov.ae to verify this certification.
www.sgs.com
Any changes or modification on this certificate will affect its validity.
SGS Gulf Limited (DAFZ Branch)
Office # 625, Building 5/WA, Al Qudra Street, Dubai Airport Free Zone
Dubai - United Arab Emirates

+971 4 2283980
www.sgs.com
Me.Sgs.Emas@sgs.com

تأكد من صحة هذه الشهادة برعي زيارة موقع هيئة الإمارات للمواصفات والمقاييس على الإنترنت: www.esma.gov.ae
أي تغيير أو تعديل في هذه الشهادة يماحها
إن عني إن جلد إيميل الإزعج المنطقة الحرة دبي
مكتب رقم 625 - مبنى 5/WA شارع القدس المنطقة الحرة في مطار دبي - الإمارات العربية المتحدة

Exhaust Fans

CERTIFICATES



هيئة الإمارات للمواصفات والمقاييس
Emirates Authority For Standardization & Metrology

شهادة مطابقة
CERTIFICATE OF CONFORMITY



Certificate Number:	18-06-7675/E18-06-007560	رقم الشهادة:
Issue Date:	04-June-2018	تاريخ الاصدار:
Valid Until:	03-June-2019	صالحه لغاية:
Issued To:	Danube Building Materials FZCO P.O. Box 18022, Dubai, United Arab Emirates	اصدرت الى:

Product Category:	Lighting Products	منتجات الإضاءة:	تصنيف المنتج:
Product Name:	LED Panel Light	نوعه إضاءة للبد:	اسم المنتج:
Product Details:	See Schedule Of Certification	انظر بيان التسجيل المرفق:	لتفاصيل المنتج:

Product is registered under the Emirates Conformity Assessment Scheme (ECAS) based on compliance to the following requirements:

UAE.S IEC 60598-2-2; UAE.S IEC 60598-2-1; UAE.S IEC 60598-1	UAE.S IEC 60598-2-2; UAE.S IEC 60598-2-1; UAE.S IEC 60598-1
--	--





جهة معيّنة من قبل هيئة الإمارات للمواصفات والمقاييس
Notified Body by Emirates Authority for Standardization & Metrology

Visit ESMA website www.esma.gov.ae to verify this certification.
www.esma.gov.ae
Any changes or modification on this certificate will affect its validity.

SGS Gulf Limited (DAFZ Branch)
Office # 408, Building- 9WA, Al Qudus Street, Dubai Airport Free Zone
Dubai - United Arab Emirates

التأكد من صحة هذه الشهادة يرجى زيارة موقع هيئة الإمارات للمواصفات والمقاييس على الإنترنت: www.esma.gov.ae
أي تغيير أو تعديل على هذه الشهادة ينعكس على صحتها.

من هي ان جلف ليمتد فرع المنطقة الحرة بدعارة (سج)
مكتب رقم 408، مبنى 9WA، شارع القدس، المنطقة الحرة في مطار دبي، الإمارات العربية المتحدة

+971 4 2283990
www.iec.sgs.com
Me.Sgs.Esma@sgs.com

+971 4 2283990
www.iec.sgs.com
Me.Sgs.Esma@sgs.com



هيئة الإمارات للمواصفات والمقاييس
Emirates Authority For Standardization & Metrology

شهادة مطابقة
CERTIFICATE OF CONFORMITY



Certificate Number:	18-04-4931/E18-04-004984	رقم الشهادة:
Issue Date:	05-April-2018	تاريخ الاصدار:
Valid Until:	04-April-2019	صالحه لغاية:
Issued To:	Danube Building Materials FZCO P.O. Box 18022, Dubai, United Arab Emirates	اصدرت الى:

Product Category:	Fan & Fan Systems	مراوح و أنظمة المراوح:	تصنيف المنتج:
Product Name:	Celling fan	مروحة السقف:	اسم المنتج:
Product Details:	See Schedule Of Certification	انظر بيان التسجيل المرفق:	لتفاصيل المنتج:

Product is registered under the Emirates Conformity Assessment Scheme (ECAS) based on compliance to the following requirements:

UAE.S IEC 60335-2-80, UAE.S IEC 60335-1	UAE.S IEC 60335-2-80, UAE.S IEC 60335-1
---	---





جهة معيّنة من قبل هيئة الإمارات للمواصفات والمقاييس
Notified Body by Emirates Authority for Standardization & Metrology

Visit ESMA website www.esma.gov.ae to verify this certification.
www.esma.gov.ae
Any changes or modification on this certificate will affect its validity.

SGS Gulf Limited (DAFZ Branch)
Office # 408, Building- 9WA, Al Qudus Street, Dubai Airport Free Zone
Dubai - United Arab Emirates

التأكد من صحة هذه الشهادة يرجى زيارة موقع هيئة الإمارات للمواصفات والمقاييس على الإنترنت: www.esma.gov.ae
أي تغيير أو تعديل على هذه الشهادة ينعكس على صحتها.

من هي ان جلف ليمتد فرع المنطقة الحرة بدعارة (سج)
مكتب رقم 408، مبنى 9WA، شارع القدس، المنطقة الحرة في مطار دبي، الإمارات العربية المتحدة

+971 4 2283990
www.iec.sgs.com
Me.Sgs.Esma@sgs.com

+971 4 2283990
www.iec.sgs.com
Me.Sgs.Esma@sgs.com

LED Panel Light

Ceiling fan

CERTIFICATES



هيئة الإمارات للمواصفات والمقاييس
Emirates Authority For Standardization & Metrology

شهادة مطابقة CERTIFICATE OF CONFORMITY



Certificate Number: 17-06-5445/E/17-04-002946
Issue Date: 18-June-2017
Valid Until: 17-June-2018
Issued To: Danube Building Materials FZCO
P.O. Box 18022, Danube, United Arab Emirates

رقم الشهادة:
تاريخ الإصدار:
صلاحه لغاية:
أصدرت إلى:

Product Category: Lighting Products
Product Name: Recessed LED Laminaire
Product Details: See Schedule Of Certification

تصنيف المنتج: منتجات الإضاءة
اسم المنتج: وحدة تيد الأترة العفارة
تفاصيل المنتج: انظر بيان التسجيل المرفق

Product is registered under the Emirates Conformity Assessment Scheme (ECAS) based on compliance to the following requirements:

المنتج مسجل في نظام توكيم المطابقة الإماراتي (إيكاس) بناء على مطابقتها للمتطلبات التالية:

UAE.S IEC 60598-2-2, UAE.S IEC 60598-1
UAE.S IEC 60598-2-2, UAE.S IEC 60598-1

SGS

جهة معتمدة من قبل هيئة الإمارات للمواصفات والمقاييس
Notified Body by Emirates Authority for Standardization & Metrology



Visit ESMA website www.esma.gov.ae to verify this certification.
www.esma.gov.ae
Any changes or modification on this certificate will affect its validity.
SGS Gulf Limited (DAFZ Branch)
Office # 601, Building- SWA, Al Quds Street, Dubai Airport Free Zone
Dubai - United Arab Emirates



تأكد من صحة هذه الشهادة بزعمي زيارة موقع هيئة الإمارات للمواصفات والمقاييس على الإنترنت - www.esma.gov.ae أو التمسك أو تغيير رقم هذه الشهادة بغيرها.
أي تغيير من هذا النموذج خارج المنطقة الحرة بمسار (إم) - مكتب رقم (601) مبنى SWA - شارع القدس، المنطقة الحرة في مطار دبي - الإمارات العربية المتحدة

LED Lights



هيئة الإمارات للمواصفات والمقاييس
Emirates Authority For Standardization & Metrology

شهادة مطابقة CERTIFICATE OF CONFORMITY



Certificate Number: 18-02-2962/E/18-02-003053
Issue Date: 28-February-2018
Valid Until: 27-February-2019
Issued To: Danube Building Materials FZCO
P.O. Box 18022, Dubai, United Arab Emirates

رقم الشهادة:
تاريخ الإصدار:
صلاحه لغاية:
أصدرت إلى:

Product Category: Switches & Dimmers
Product Name: Flush-Type Switch for Fixed Installation
Product Details: See Schedule Of Certification

تصنيف المنتج: مفتاح التشغيل ومفتاح التحكم بشفة الإضاءة
اسم المنتج: مفتاح كهربوي للترغيبات الثابتة
تفاصيل المنتج: انظر بيان التسجيل المرفق

Product is registered under the Emirates Conformity Assessment Scheme (ECAS) based on compliance to the following requirements:

المنتج مسجل في نظام توكيم المطابقة الإماراتي (إيكاس) بناء على مطابقتها للمتطلبات التالية:

UAE.S IEC 60669-1
UAE.S IEC 60669-1

SGS

جهة معتمدة من قبل هيئة الإمارات للمواصفات والمقاييس
Notified Body by Emirates Authority for Standardization & Metrology



Visit ESMA website www.esma.gov.ae to verify this certification.
www.esma.gov.ae
Any changes or modification on this certificate will affect its validity.
SGS Gulf Limited (DAFZ Branch)
Office # 601, Building- SWA, Al Quds Street, Dubai Airport Free Zone
Dubai - United Arab Emirates



تأكد من صحة هذه الشهادة بزعمي زيارة موقع هيئة الإمارات للمواصفات والمقاييس على الإنترنت - www.esma.gov.ae أي التمسك أو تغيير رقم هذه الشهادة بغيرها.
أي تغيير من هذا النموذج خارج المنطقة الحرة بمسار (إم) - مكتب رقم (601) مبنى SWA - شارع القدس، المنطقة الحرة في مطار دبي - الإمارات العربية المتحدة

Wiring Devices

A large rectangular area with a vertical line on the left side and horizontal blue lines, resembling a table or a list of items.



Milano
Bright Light Bright Life

Milano Italy Office: Piazza Castello 26,
20121 Milano (MI), Italy
Website: www.milanoitalysrl.com
E-mail: sales@milanoitalysrl.com

OUR GLOBAL PRESENCE:

Regional Office: PO Box: 18022, Jebel Ali Freezone, Dubai, UAE

Our Branches: U.A.E | Bahrain | Oman | Saudi Arabia | Qatar | India | China | Kenya

Distributor Network:

Middle East: Kuwait | Iran | Iraq | Lebanon | Jordan | Syria

Africa: Nigeria | Libya | Sudan | Djibouti | Somalia | Ethiopia | Uganda | Rwanda | Tanzania | Kenya | Mauritius | Seychelles

Asia: Sri Lanka | Bangladesh | Nepal | Myanmar | Maldives | Pakistan | Uzbekistan | Tajikistan

Russia: Moscow

991000100021